

ALL AMERICAN SCOREBOARDS™



Everbrite

Site Installation | Model MP-8454

Rev. 8/1/2011

SCOREBOARD SITE INSTALLATION INSTRUCTIONS

CAUTION: All American Scoreboards (AAS) recommends the sign be installed by a licensed contractor, and must meet all local and national building codes.

NOTE: AAS RECOMMENDS USING A BOOM/FORKLIFT/CRANE OF SUITABLE SIZE TO USE IN INSTALLATION.

Unpacking/Pre-Installation

Dependent on the Model ordered, the All American Scoreboard unit comes crated with different items attached and/or unattached and with different installation hardware.

! OPERATION OF THE UNIT WITH THE ELECTRICAL CIRCUITRY EXPOSED IS DANGEROUS. BE SURE ALL TOOLS AND ANY OTHER MATERIALS ARE REMOVED FROM THE UNIT, AND ALL ACCESS COVERS ARE REPLACED AND CLOSED BEFORE POWER IS TURNED ON.

NOTE: Take care uncrating as not to damage the units.

The shipment should include:

- Installation instructions (this document).
- Operator's Manual.
- LED Scoreboard Cabinet(s).
- Keypad Console.
- Scoreboard Antenna (Radio System only)
- Junction Box (Hard-wire only)
- Mounting Hardware (see parts list.)

NOTE: Upon receipt, check for visible damage. If damage is found at the time of delivery, consignee must obtain an 'Inspection of Bad Order' from the delivering carrier.

If damage is found after shipment has been accepted, visit www.AllAmericanScoreboards.com for the damage claim procedure or contact your sales rep.

- Installation Steps -

Prior to installation, set I-Beams in required concrete footing. Footing depth varies heavily by soil conditions, climate and environmental factors. Depth of footing must comply with local ordinances. I-Beams must be level.

Step 1: Scoreboards are installed from the bottom up and connected by pins. Measure from the top of the I-Beams to the appropriate length so the top of the scoreboard (or scoreboard + ad panels) will be flush with the top of the I-Beam.

Step 2: Screw Threaded Rods (Item 7) into the Spring Nuts (Item 8) and tighten using 1/2" Nut and Lock Washer (Items 9 and 10).

Step 3: Lift the cabinet and center between 2 appropriate poles. **It is critical that the cabinet is level to ensure entire scoreboard, ad panels, etc are also level.**

Step 4: Install Spring Nuts with Threaded Rods by sliding in from the end or twist them CLOCKWISE into the mounting channels on the back of the scoreboard (the spring nuts have a rounded edges for twisting clockwise only), approximate position on each side of the I-beams (See Figure 2).

Step 5: After leveling and centering the scoreboard, secure to I-beams using the supplied 12" strut (Item 4) and 1/2" Flat Washer, Lock Washer and Hex Nut (Figures 9,10,11), taking care not over tighten and strip or pull the spring nuts out, **50/60 FT/LB torque max** (See Figure 2, Detail A).

If no Ad Panels will be installed, skip to Step 7 .

Step 6: If using an Advertiser Panel, using a 9/16" drill, drill through the I-Beam to install the Mounting Angle (Item 5) on to the outside top of the I-Beam (see Figure 1). Attach a two piece Advertiser Panel using a 3/16" bar on top with 4-3/8" bolts, nuts and washers and the sides with 2-3/8" bolts, nuts and washers.

Step 7: HARD-WIRE ONLY. Install the Junction Box at chosen location (i.e. press box or dug-out) and hook-up Power/Data Cable to terminal block (see Figure 3 Detail-D).

Step 8: Attach the grounding wire to ground.

Step 9: Install the cable conduit and the power cut of switch box (recommended) onto the beam and run the power through the conduit to the sign.

Step 10: HARD-WIRE ONLY. Install the cable conduit onto the beam and run the data cable from the junction box through the conduit to the data box on the back of the scoreboard. Attach the data cable - Pin 5 on console (and scorer's booth junction box) will connect to the Blue and White wire, Pin 4 will connect to the Blue Wire.

Step 11: RADIO ONLY. Remove the RED button cover from the antenna mount located on the face of the board and screw on the extra antenna.

Step 12: Attach the Board power line to the terminal block in the power supply assembly; Black to Line, White to Neutral, Green to Ground. Reinstall cover.



Step 13: Reinstall board face into cabinet frame.

Step 24: Power up scoreboard and run set-up as described in Operator's Manual.

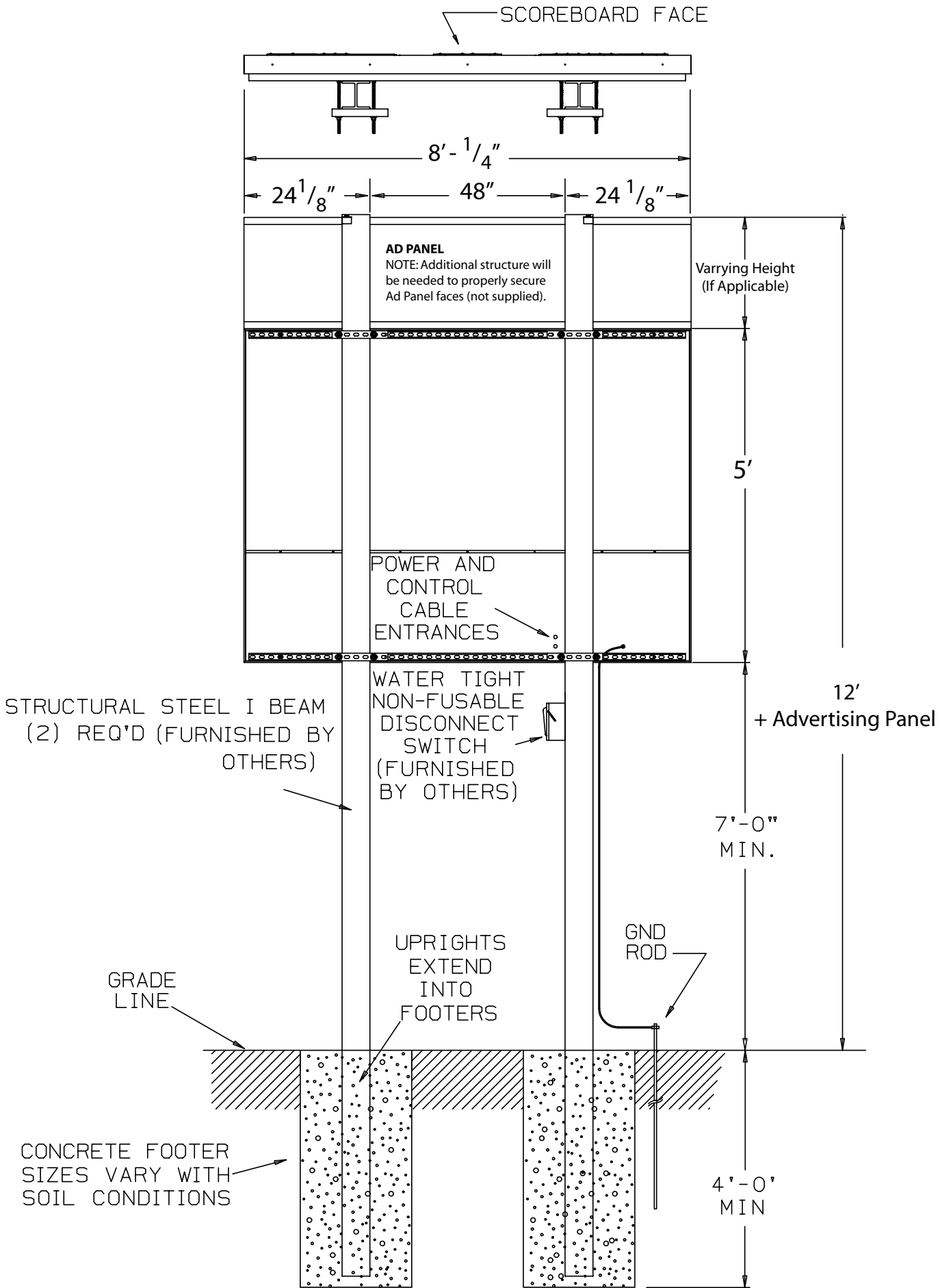

NOTE: Foundation shown for illustration only. Actual foundation needs to meet national and local building codes. Sites must be surveyed by qualified engineer. All measurements are for reference only.

Figure 2: Mounting and Ad Panel Detail.

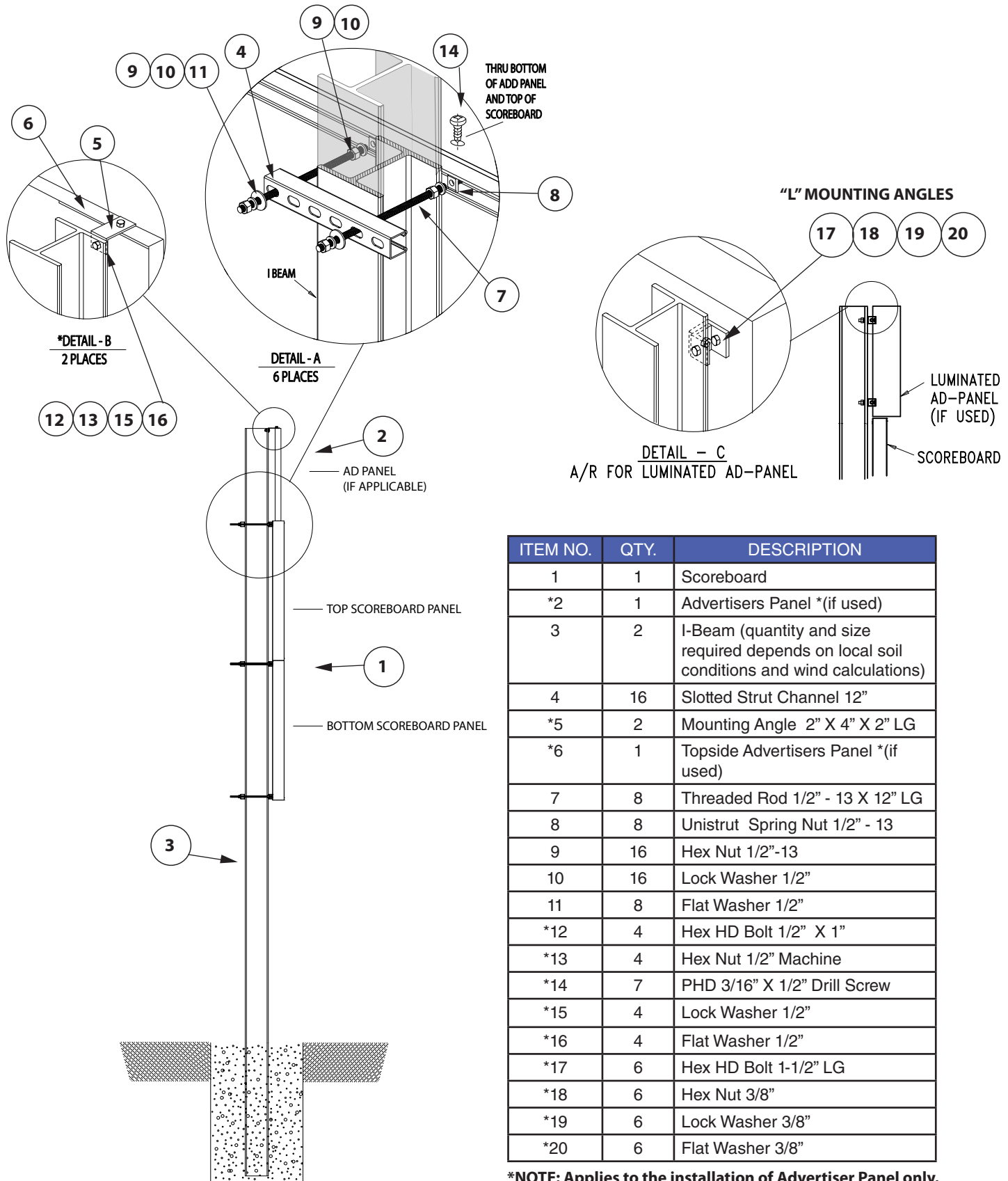

ITEM NO.	QTY.	DESCRIPTION
1	1	Scoreboard
*2	1	Advertisers Panel *(if used)
3	2	I-Beam (quantity and size required depends on local soil conditions and wind calculations)
4	16	Slotted Strut Channel 12"
*5	2	Mounting Angle 2" X 4" X 2" LG
*6	1	Topside Advertisers Panel *(if used)
7	8	Threaded Rod 1/2" - 13 X 12" LG
8	8	Unistrut Spring Nut 1/2" - 13
9	16	Hex Nut 1/2"-13
10	16	Lock Washer 1/2"
11	8	Flat Washer 1/2"
*12	4	Hex HD Bolt 1/2" X 1"
*13	4	Hex Nut 1/2" Machine
*14	7	PHD 3/16" X 1/2" Drill Screw
*15	4	Lock Washer 1/2"
*16	4	Flat Washer 1/2"
*17	6	Hex HD Bolt 1-1/2" LG
*18	6	Hex Nut 3/8"
*19	6	Lock Washer 3/8"
*20	6	Flat Washer 3/8"

*NOTE: Applies to the installation of Advertiser Panel only.

NOTE: Foundation shown for illustration only. Actual foundation needs to meet national and local building codes.

Hardwire Scoreboard Wiring With a Standard Junction Box

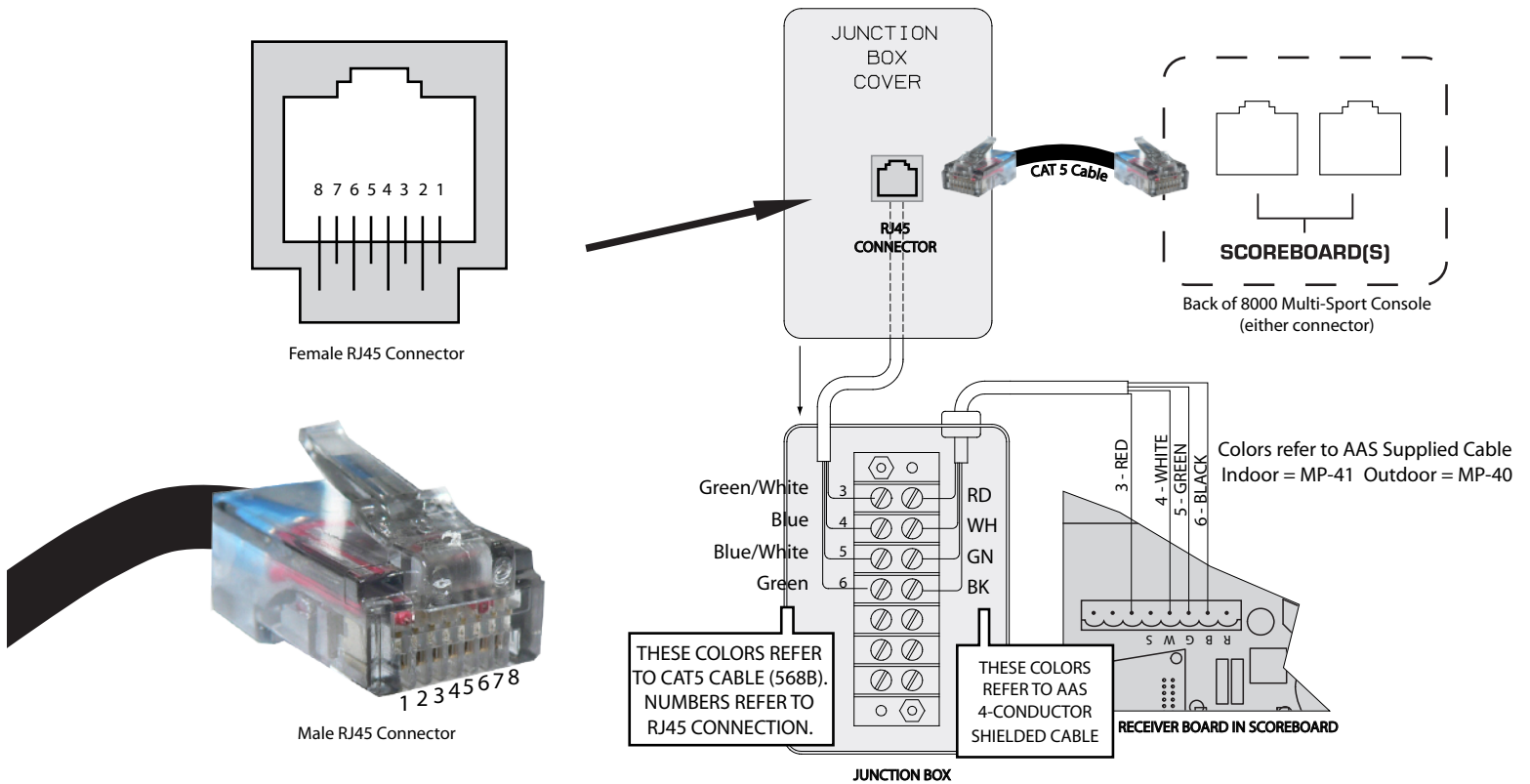

Wiring a Supplemental Display With a Single Junction Box

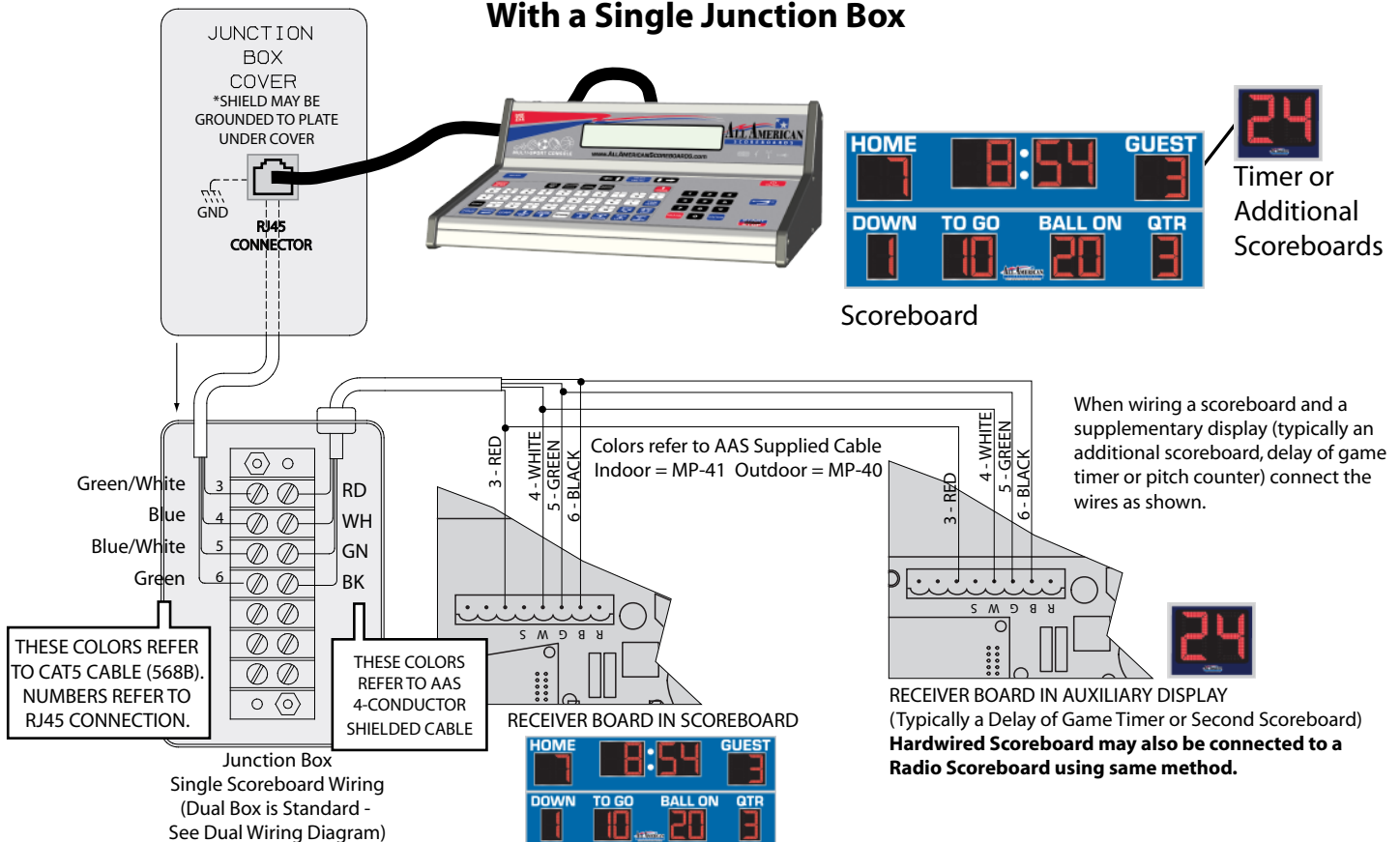

Hard Wire Setup / Hardwire Override Capable

Using a Dual Capable Junction Box

All radio scoreboards have the ability to be used as a hardwire. When installed properly, the radio on the scoreboard will turn off when a console is plugged into the hardwire input. **Unless proper wiring (Leads 3 & 6) is run to the RJ45 Terminal Box and Junction Box, the radio will need to be removed from the scoreboard to connect via hard wire. To avoid this situation, two additional wires are required to allow the hardwire data to override the radio signal (Leads 3 & 6).**

The 8000 Series Console can plug directly into the scoreboard via a standard CAT5 cable and RJ45 connections. All American Scoreboards recommends using a junction box (either a standard single or a dual capable). Type of junction box and cable lengths will be determined at point of sale.

Outdoor boards will require a water tight junction box. Data connections will be directly connected to the receiver board in scoreboard. Data connection and AC power cannot run in same conduit.

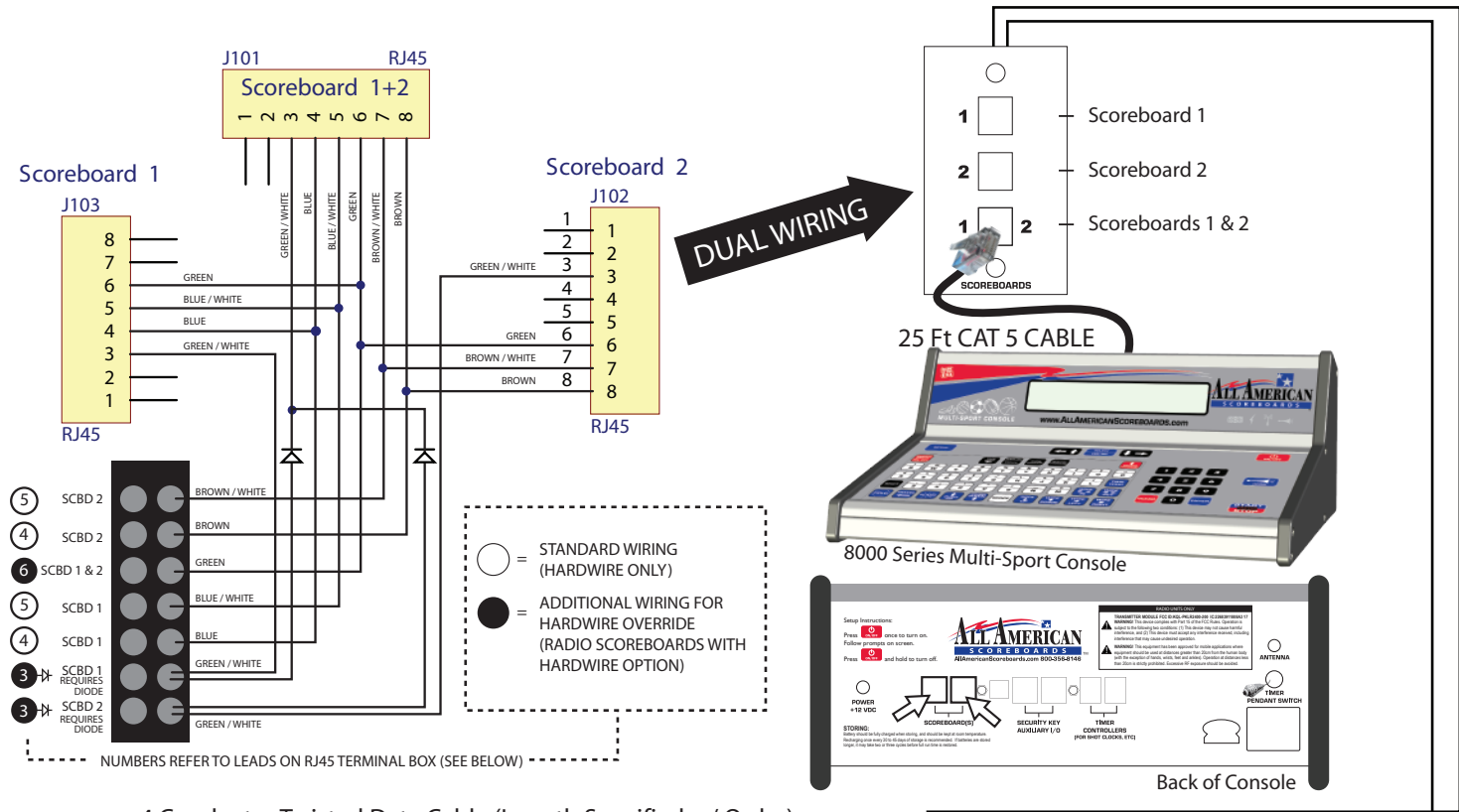

4 Conductor Twisted Data Cable (Length Specified w/ Order)

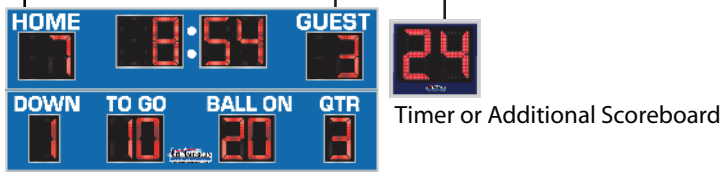
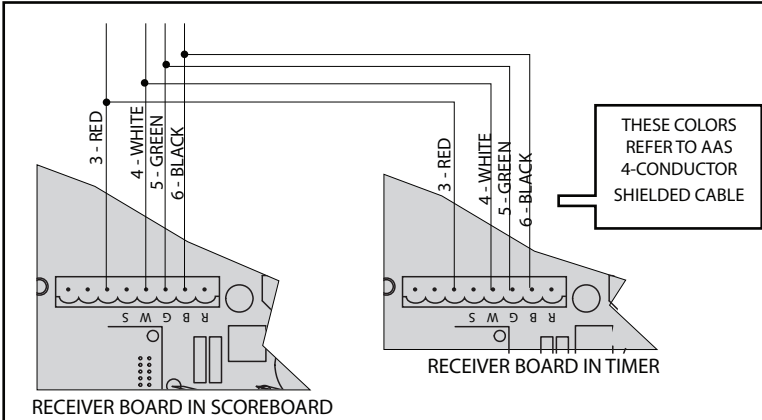

Scoreboard 1

*Actual scoreboard configurations may differ.

4 Conductor Twisted Data Cable (Length Specified w/ Order)

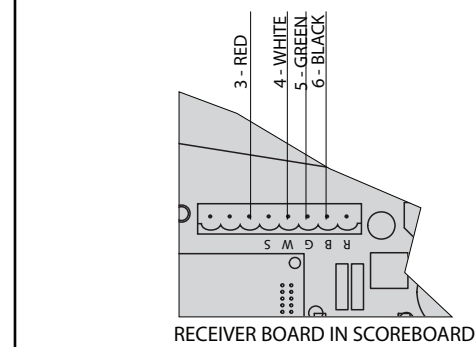

Scoreboard 2 or Auxiliary Board (Scoreboard, Timer, Pitch Count, etc.)

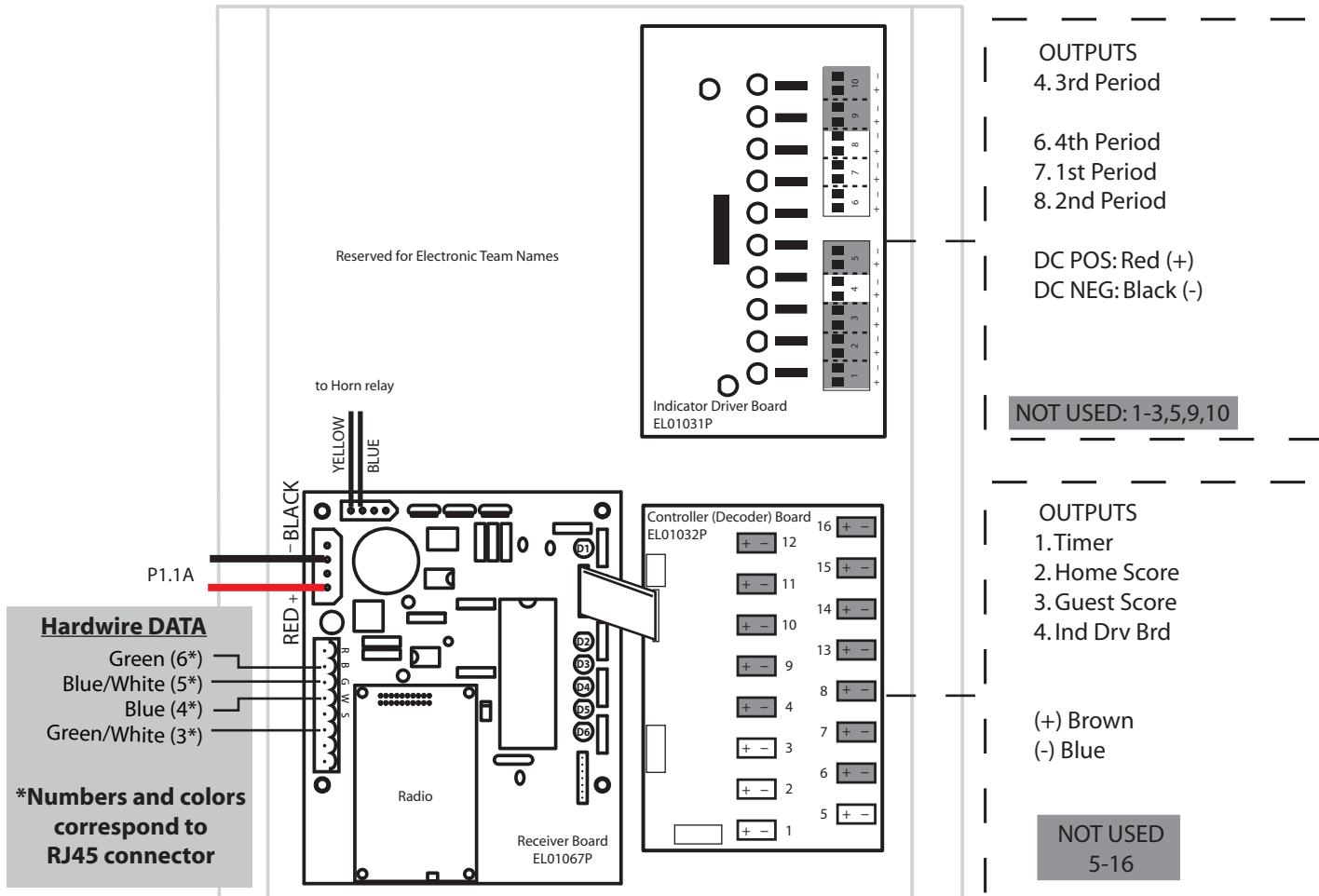

8454 Football Controller Plate

CONTROLLER PLATE BEHIND HOME SCORE

Scoreboard Type: 300

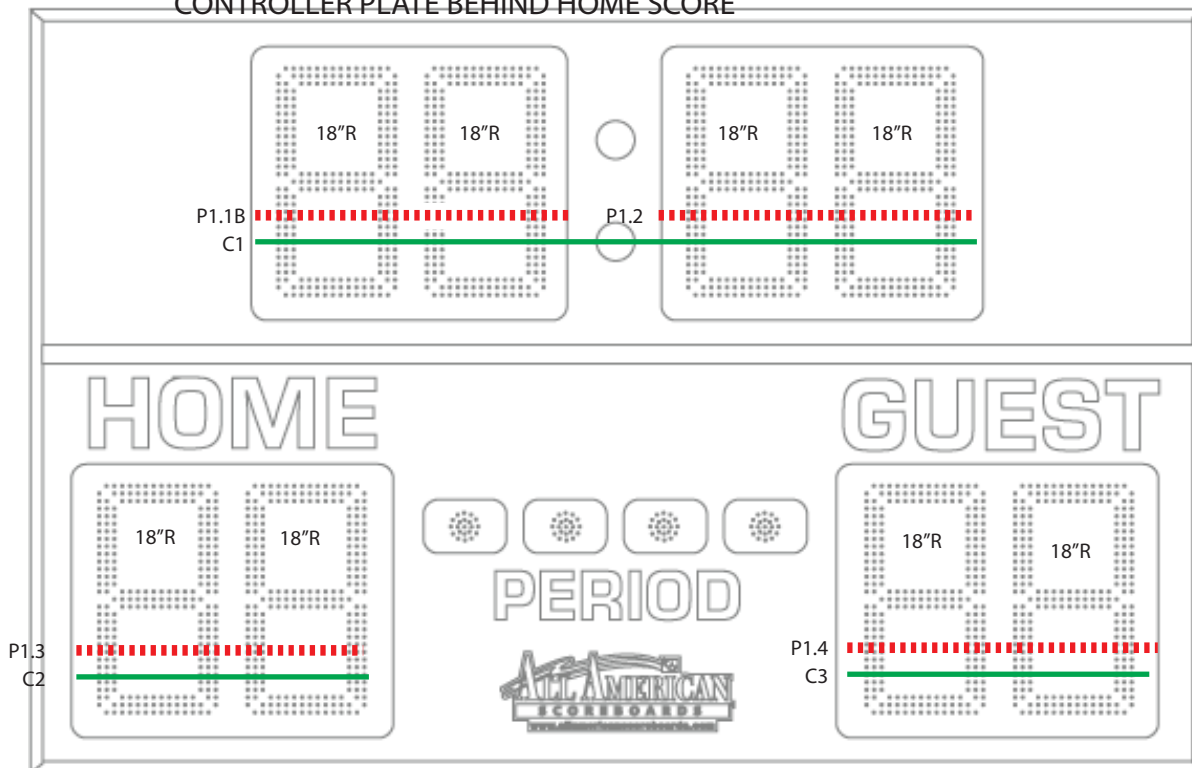

Power Supply Outputs (Full Brightness & Full Digits): P1.1 ≈ 2.98A P1.2 ≈ 2.38A P1.3 ≈ 2.38A P1.4 ≈ 2.38A

"C" refers to controller board output. If Indicators are used, C4 data will go to the Indicator Driver Board and then to the digit(s).

— = DATA - - - - - = 10.5VDC POWER

115 VAC / 60 Hz - 3.0 Amps