



A Product of Everbrite 401 S. Main St., Pardeeville, WI 53954

Phone: (800) 356-8146 Fax: (608) 429-9216

www.allamericanscoreboards.com

OPERATING INSTRUCTIONS AND SERVICE MANUAL
LED Racing Scoreboard
MP-7820

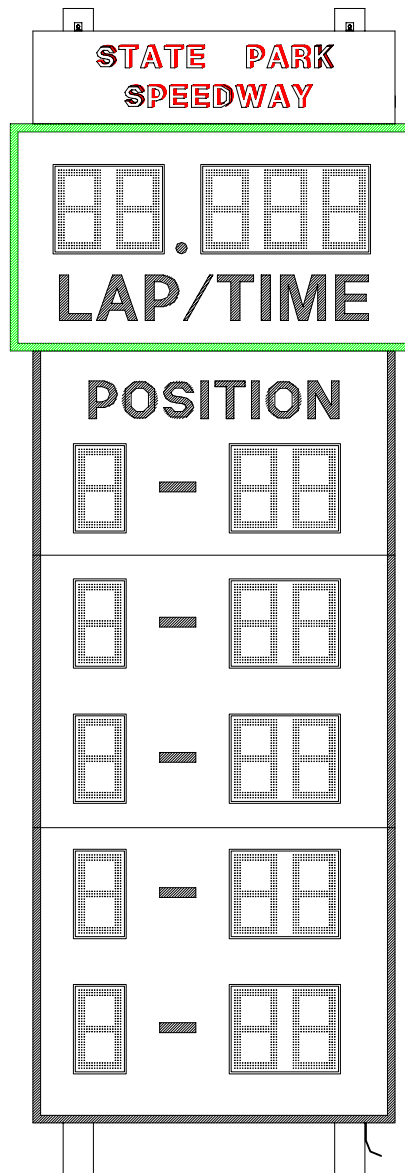

EFFECTIVE S.N. 18,725, June, 2006

TABLE OF CONTENTS

1. General Information Page 3

- 1.1 Description
- 1.2 Identification
- 1.3 Damage
- 1.4 Damage Claim Procedure

2. Installation Page 4

- 2.1 General Information
- 2.2 Installation
- 2.3 Electrical Connection

3. Control Console Operation Page 5 - 7

- 3.4 Race Mode
- 3.3 Time Trials
- 3.4 Initializing Scoreboard
- 3.3 Console Power
- 3.2 Console Display
- 3.1 Scoreboard Power

4. Maintenance and Troubleshooting Page 8 - 11

- 4.1 Introduction
- 4.2 Test Equipment
- 4.3 Troubleshooting
- 4.4 Troubleshooting Guide

5. Replacement Parts List Page 12 - 14

- 5.1 Scoreboard Display Parts
- 5.2 Controller Assembly

6. Diagrams Page 15 - 22

- 6.1 Control Console Keyboard & Slipsheet Layout
- 6.2 Scoreboard System Layout
- 6.3 Power Wiring
- 6.4 Scoreboard System Layout
- 6.5 Controller Assembly Wiring
- 6.6 Installation Drawing
- 6.7 Installation Drawing Cont.
- 6.8 Installation Drawing Cont.

1. GENERAL INFORMATION

1.1 DESCRIPTION

Your All-American scoreboard has been carefully inspected and tested before leaving the factory. It is possible, however, that components may be loosened or forced out of adjustment in transit. If this occurs, follow the troubleshooting guide (section 4). If equipment then fails to operate, contact immediately:

ALL-AMERICAN Service Department
P.O. Box 100
Pardeeville, WI 53954
Toll Free: 800-356-8146
score@everbrite.com

Parts being returned for repair are to be sent to:

ALL-AMERICAN Service Department
401 S. Main Street
Pardeeville, WI 53954

NOTE

If you need to send parts in for repair, please call the ALL AMERICAN service department for a returned goods authorization (RGA) number. This will help us track you order and process it more quickly & efficiently.

1.2 Identification

ALL-AMERICAN uses a serial number for scoreboard identification. The serial number tags are located on the back of the control console and the lower right hand corner on the face of the scoreboard display. When contacting the factory for assistance it is important that the model number and serial numbers are known.

1.3 Damage

Upon receipt of scoreboard, check for visible damage. If this occurs, or if damage is found after shipment has been accepted, follow the damage claim procedure.

1.4 Damage Claim Procedure

If damage is not immediately noticed, but is noticed after unpacking the scoreboard, contact the delivery company immediately. It is very important that the product is inspected within 24-48 hours of receipt, and if damage is noticed, the carrier must be notified immediately. All American Scoreboards should also be contacted at this time and informed of any replacement parts or repairs necessary.

2. INSTALLATION

2.1 General Information

Shipping papers accompany each scoreboard. Check carefully to see that you receive the following:

1 ea Racing Display (4 Pieces) 1 ea Control Console 1 ea Service Manual 1 ea Mounting Hardware Package ? ft. control cable (if ordered) 1 ea Horn (if ordered)

2.2 Installation

Select the location best suited for visibility by the majority of spectators. Preferred position is facing east or north to avoid direct sunlight on the face of the scoreboard (if day games are played).

For permanent mounting to uprights, see the enclosed installation drawing in section 6.

Consult Section 6 for junction box and scoreboard wiring.

2.3 Electrical connections

The MP-7820 scoreboard requires one 120 VAC 20 AMP circuit.

IMPORTANT !!!

To protect the control from damage, it is advisable to disconnect the control and store in a dry secure area when not in use.

NOTE

This equipment is **UL** approved and complies with the requirements in part 15 of the FCC rules for a class A computing device. Operation of this equipment in a residential area may cause unacceptable interference to radio and television reception, requiring the operator to take whatever steps are necessary to correct the interference.

3. CONTROL CONSOLE OPERATION

3.1 Scoreboard Power

Turn on the branch circuit to the scoreboard. The time will will show ".00".

3.2 Console Display

The Liquid Crystal Display module displays the scoreboard information entered from control console. The following information is displayed continuously: Time, Lap, & Position.

3.3 Console Power

Plug the power adaptor into the control console and into a 120 VAC wall outlet.

Push once to turn the console on.

Push a second time to shut the console off.

When first turned on; the console display should show as follows:

**RACING CONTROL
MP-7000 V 2.00.A 2003**

3.4 Initializing Scoreboard

Enter the two digit code (88) shown in the lower left corner of the keyboard as in

the following example: Push .

When the proper code has been entered, the console display will show as follows.

**TOP 5
LAP 0**

The scoreboard display will now show **:00** in the time section.

3.3 Time Trials

Push **TIME/RACE** to enter the time trial mode. The scoreboard time will show **.00** and the LCD display will show



Select the laps to be time trialed by pushing **1 LAP** , **2 LAP** , or **3 LAP** .

The LCD display will reflect your selection.

Push **EE ENABLE** to enable the electric eye.

When the EE is enabled the LCD display will show EE in the lower left corner.

If, for example, car number 55 is going to time trial; Push **POS 1** ,

and the car number **5** **5** , and then **ENTER** .

Car number 55 would appear on the scoreboard in position 1, and you would be ready for time trials.

When the EE beam is broken the time will start.

The 1/100th and 1/1000 digits are blanked while the timer is running.

Push **EE ENABLE** at any time to disable the electric eye.

When the EE beam is broken a second time, the time will stop and the hundredths and thousandths digits will display on the scoreboard and LCD display.

If you are timing 2 or 3 laps at a time, when the car breaks the EE beam the second time, the time displayed on the scoreboard will stop for two seconds and then resume timing the second lap. The LCD on the control console will show the time for the first lap in position 1 and the elapsed time for the second lap in position 2.

After the time trial you may post the lap times as follows: **TIME RESET** Push to reset the times to zero. The scoreboard will now read **.00** , and the times on the LCD display will all revert to zeroes.

Now push **1** **8** **4** **8** **3** **ENTER** ,then and the time 18.483 will post on the scoreboard.

If a car starts to time trial but doesn't finish the lap, you may record the times for any completed laps, then push **TIME RESET** to reset the scoreboard and LCD displays.

You may now post the lap time of the completed lap and you are now ready for the next car to time trial.

3.4 Race Mode

The LCD shows the car positions for five (5) cars and the Lap number at all times.

Push **LAP +1** to increment the lap counter.

Push **LAP - 1** to decrement the lap counter.

Push **LAP** followed by the desired number(s), then **ENTER** to correct the Lap counter.

Push **POS 1** followed by the Car #, then **ENTER** to load the 1st Place Car #.

(Repeat the procedure for position two thru position ten)

If a car drops out during the race, you may push **POS 1** through **POS 10** for the position that car was running in, then **SHIFT** , to clear that car number and shift all following positions up.

3.5 Dimmer

Push **DIM** to dim the lamps during night use.

WARNING!!!

120 VAC wires are exposed whenever the cover over the controller assembly is removed from the scoreboard. Use extreme caution during troubleshooting or repair. To avoid possible damage to equipment or personal injury, always turn off the main power before removing the cover or replacing assemblies, or replacing lamps.

4.0 MAINTENANCE AND TROUBLESHOOTING

4.1 Introduction

This section gives maintenance and troubleshooting information. Included are troubleshooting guides for typical scoreboard malfunctions. If the cause of a problem cannot be determined, please contact the Customer Service Department.

4.2 Test Equipment

A simple analog or digital voltmeter will be sufficient for all user repairable problems. Printed circuit boards requiring troubleshooting should be returned to the factory.

4.3 Troubleshooting

Whenever possible, follow the troubleshooting guides prior to contacting the Customer Service Department. If a problem not described in the guides exists, contact the customer service department immediately. Read through the appropriate troubleshooting section before beginning a repair. Refer to the diagrams in chapter 6 as an aid in troubleshooting scoreboard malfunctions.

4.4 Troubleshooting Guides

(A) Scoreboard doesn't light and console doesn't work:

- (a) Check that the main power switch is turned on and providing power to the scoreboard.
- (b) Check to see that the green Led is lit on each power supply.
- (c) Check for 24 VDC at the power supply terminals.
- (d) Check the 110 VAC power connections and voltages at the scoreboard.
- (e) Replace any defective or blown fuses.
- (f) Check for 12 to 16 VDC on the red and black wires at the data cable terminal block.
- (g) Contact the Customer Service Department.

(B) Scoreboard digits:

- (a) Check all connections.
- (b) Turn the main power "on".
- (c) If the scoreboard still doesn't light, check the items in section (A), power supply voltage and fuses.
- (d) Check if LED D1 on the receiver board is lit. If not, check that the receiver board is plugged into the power supply board, then contact the customer service department.
- (e) Check to see that the LED on the first driver board (closest to receiver) is flashing. If not, check the data cable connections (orange and grey wires) from the receiver to the drivers, and check to be sure that the power connection to the driver board is OK.
- (f) If the driver board LED is still not flashing, connect a different driver board to the receiver (first in line). If the LED is now flashing, the first driver board should be replaced. Otherwise the problem is on the receiver board.

(C) The scoreboard digits light but the console doesn't work:

- (a) For a cable connected system, check for 12 to 16 VDC between the red and black wires in the junction box. For wireless consoles, check the output of the wall transformer by unplugging it from the console, putting the + meter lead into the center cavity of the power plug and touching the meter lead to the metal shell. The reading should be at least 10 VDC.
- (b) If the voltage is 10 V or more, turn on and code in the console, even though it may not appear to be working. Listen for beep sounds when pressing the keys, and see if the scoreboard responds at all. If the scoreboard is radio controlled, go to section D, step 3. Otherwise contact customer service with results or see Advanced Troubleshooting, in section C.
- (c) If the voltage from step 1 is zero, measure the voltage on the red and black wires at the terminal block inside the scoreboard. If the voltage is still zero, go to section A, step 3. Otherwise check the cable to the junction box for continuity.
- (d) Refer to advanced troubleshooting, section B to connect the console directly to the receiver board.

(D) The scoreboard digits light, the console works, but there is no control of the scoreboard:

- (a) If the scoreboard is a hardwired system, check for 1 to 4 volts AC on the green and white wires at the junction box (console on and coded in). Then go to step 6.
- (b) With wireless consoles, be sure that the battery (if so equipped) is fully charged, or better still, use the wall transformer to power the console.
- (c) Check the LED on the radio adapter board inside the scoreboard. If it is lit, turn the console off. This LED should go out about 5 seconds later. Turning the console on again should relight the LED.
- (d) Bring the console within 10 to 25 feet of the scoreboard and test again. If the radio adapter LED now works, check and tighten antenna connections as necessary, both in the scoreboard and in the console. CAUTION: the antenna connection at the radio can be easily broken. Push or pull the connector STRAIGHT on or off!
- (e) Check to see if D1 is lit. If not, check that the receiver board is plugged into the power supply board, then contact the customer service department.
- (f) With the console turned on and coded in, check to see that LED D2 on the receiver board is flashing. If not, refer to Advanced Troubleshooting for instructions on connecting the console directly to the scoreboard or contact customer service.
- (g) Starting with the driver board closest to the receiver, check to see that the LED on each driver board is flashing. If not, check the data cable connections (orange and grey wires) from the receiver to the drivers, and check to be sure that the power connection to the driver board is OK.

(E) The scoreboard works, but some lights stay on all the time:

- (a) With the main power "OFF", disconnect (and tag) the suspect digit from the driver board. Plug a known good digit into that position on the driver card. Do Not Plug the Suspect Digit into any other location!
- (b) Turn the power back on. If the good digit shows the same problem as the original digit, there is a problem on the driver PCB assembly. See the original digit, replacement parts list for the proper replacement part or refer to Advanced troubleshooting, section A to swap another driver board into that position. There may also be a problem with the digit or its cabling, continue with step 3.
- (c) Check the digit and cable assembly for shorts to the scoreboard frame and to the + and - power

leads.

- (d) Plug the suspected bad digit into another output position. USE the SAME driver board (A bad digit may be the cause of a driver board failure). If the same lights remain on, replace the digit and driver board.

(F) The scoreboard works, but some lights do not come on:

- (a) If only part of a digit works, e.g. a 0 looks like a U, go to step 6.
- (b) If one or more of the digits are completely blank, check the LED on the corresponding driver board.
- (c) If the LED is blinking, check the power connection at the opposite end of the board for 24 VDC. If not, check the power and data cable connections on the driver board.
- (d) Plug the blank digit into a known good driver board position. If it is still blank, check for broken wires or bad connections in the digit cable. Replace the digit if the cabling is OK.
- (e) If the digit now works, see the replacement parts list for the proper replacement driver board or refer to Advanced troubleshooting, section A to swap another driver board into that position.
- (f) Disconnect the suspect digit and plug a known good digit into that driver location.
- (g) If the good digit shows the same problem, see the replacement parts list for the proper replacement driver board or refer to Advanced troubleshooting, section A to swap another driver board into that position.
- (h) If the good digit is working, check for a broken wire or bad connection on the 10 pin connector.
- (i) Contact customer service for the proper replacement digit.

4.5 Advanced Troubleshooting

In emergency situations (Tournament begins in an hour), the following steps may help to make the scoreboard usable in a temporary fashion. These procedures are best performed by someone that has experience working on electronic equipment. If possible, consult with customer service before proceeding.

(A) All of the driver boards in a 7000 series scoreboard are interchangeable. However, each board has an address programmed inside its microcontroller chip. The chip from the board being replaced must be put into the new board for proper operation. Example: The scoring driver of a football board has a problem. The Ball On/Yards To Go driver can be used in its place. (Ball on and yards to go will not be usable until a new driver board is received from the factory).

- (a) Remove power from the scoreboard.
- (b) Take the bad driver board out and set it aside. Put the replacement driver in position.
- (c) Remove the processor chip from the new driver.
- (d) Carefully take the processor chip out of the old driver board and install it in the replacement board. Be sure the notched end of the chip is aligned correctly.
- (e) Put the processor chip from the new board into the defective driver board so it doesn't get lost.
- (d) Reconnect power, data, and the display cables to the new driver board.

(B) Direct connection of consoles to scoreboards can be done to ensure that the electronics is working properly. For radio controlled systems, skip to step 8.

- (a) For a hardwired system, the cover of the junction box with the connector and wire pigtail can be

used. Open the junction box and disconnect the connector wires at the terminal block.

- (b) Take the cover plate/connector assembly up to the scoreboard. Attach the red and black wires to the matching positions on the terminal block. Disconnect the red and black data cable wires (that go to the junction box).
- (c) Attach the green and white wires from the cover plate connector to the terminals on the lightning protector board where the same colored wires connect to the receiver board.
- (d) Disconnect the data cable (to the junction box) green and white wires from the lightning protector board. Mark the board so that the wires can be put back on the correct terminals.
- (e) Test the system. If it works, move the green and white wires from the cover plate connector to the other two terminals on the lightning protect board.
- (f) Test again. If the scoreboard works, there is a problem in the data cable somewhere between the scoreboard and the junction box. If not, the lightning protector board must be replaced.
- (g) The data cable can be checked by re-installing the junction box cover plate and connecting both greenwires to one of the green wire terminals on the lightning board, and doing the same with the white wires. While the scoreboard will operate with the lightning protect board bypassed in this fashion, it should be fixed as soon as possible, since the board also protects the electronics in the scoreboard from other sources of potentially damaging interference.
- (h) Radio controlled consoles may be connected directly to the scoreboard through the 12 pin radio connectors. Remove the radios and interface boards.
- (i) Using 22 gauge solid wire, connect pin 10 of the console connector to pin 10 of the scoreboard receiver board connector. Also connect pin 2 of the console connector to pin 6 on the receiver board connector.
- (j) Powering the console from the battery or wall cube, the system should operate. This eliminates any radio related communication problems.

NOTE !:

If it is necessary to operate the scoreboard this way,
keep the 2 wires as short as possible (10 ft. max),
since there is no protection on these lines,
keep them away from components that can
cause stray RF frequencies.

(C) Console problems:

- (a) Power is OK, but console does not turn on: check that the keypad connector is plugged into the main board in the console.
- (b) Console beeps, but has no display: check the ribbon cable between the main console board and the display module.
- (c) Erratic operation, abnormal display: check the socketed IC chips to be sure that they are well seated.

5. REPLACEMENT PARTS LIST

5.1 Scoreboard Display Parts

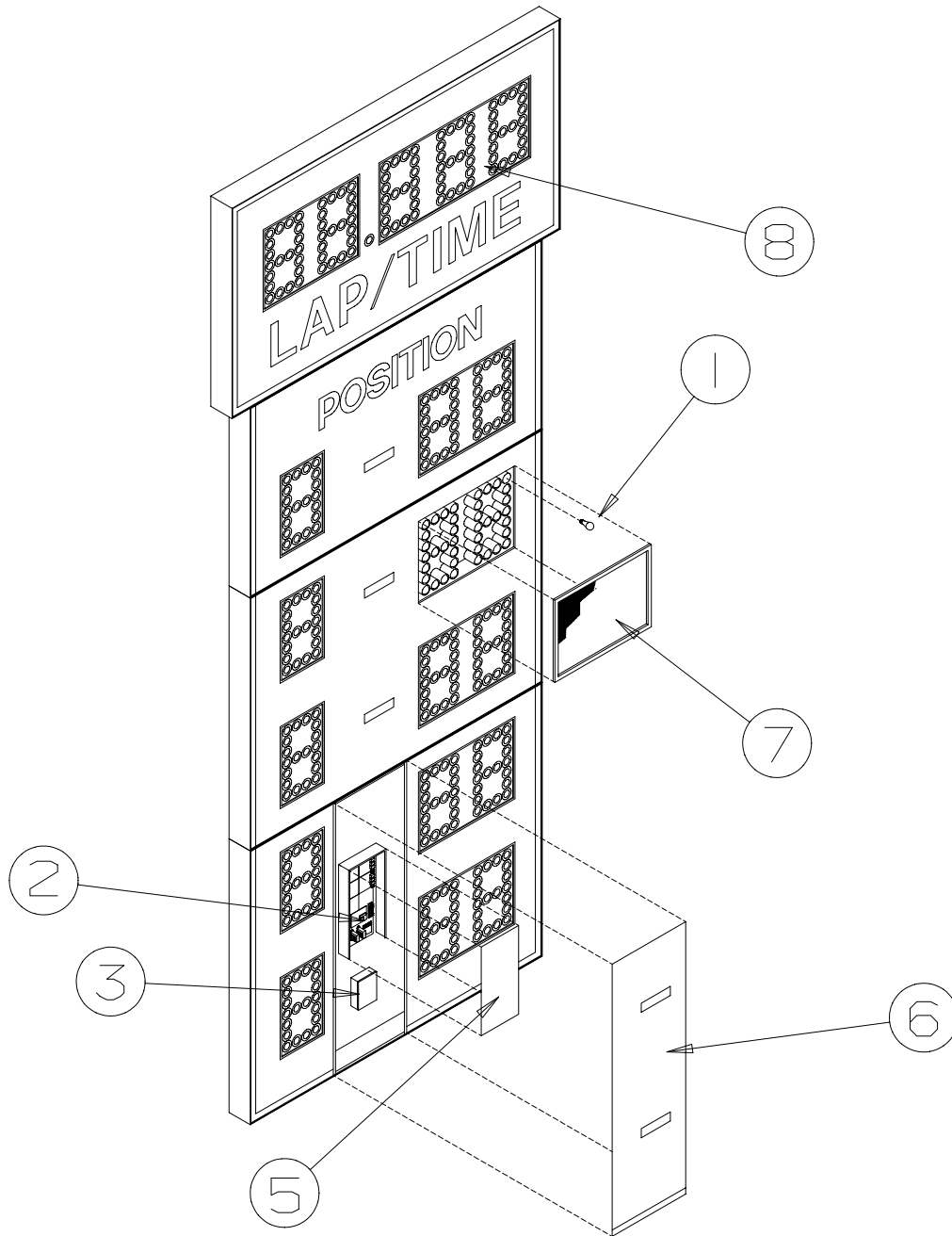

figure 1

DISPLAY ASSEMBLY

REPLACEMENT PARTS LIST (MP-7820 Racetrack)				
fig.& index	MFG PART NUMBER	DESCRIPTION	REF DES	VENDOR PART #
1-	000000	Display Assembly		150221
1-2	152101	Controller Assembly MP-7820 *****SEE FIGURE 2*****		152101
1-3	121880	Fuse, 15A 250V		ABC-15 (3AG)
1-4	LED5M24AR	24" LED Digit (top section)		
1-4	LED5M24BR	24" LED Digit (middle section)		
1-4	LED5M24CR	24" LED Digit (bottom section)		
1-7	000000	24" Window, Car Number		
1-8	152026	24" Window, Position/Minutes time		
1-9	000000	24" Window, Hundredth of a second time		
	151735 151692 930894 930895 EL057700 151682 WH009100 MP00468P 151740	Control Console MP-7000 PC BD Transmitter Connector, 6 Pin Male Cable Connector, 6 Pin Female LCD Display, 2 Line 20 Character Keypad Assembly, Ribbon Cable Assembly, 14C 8" Keyboard Enclosure 25ft Cable Assembly		151735 HB002400 WH009100
	151915 930895 000000 000000	Junction Box, Single MP-7000 Connector, 6 Pin Female Cable Direct Burial, MP-40 Control Terminal Strip, 7C		151915 8723 670-7
	150257	Optional Electric Eyes		150257

5.2 Scoreboard Controller Assembly Parts

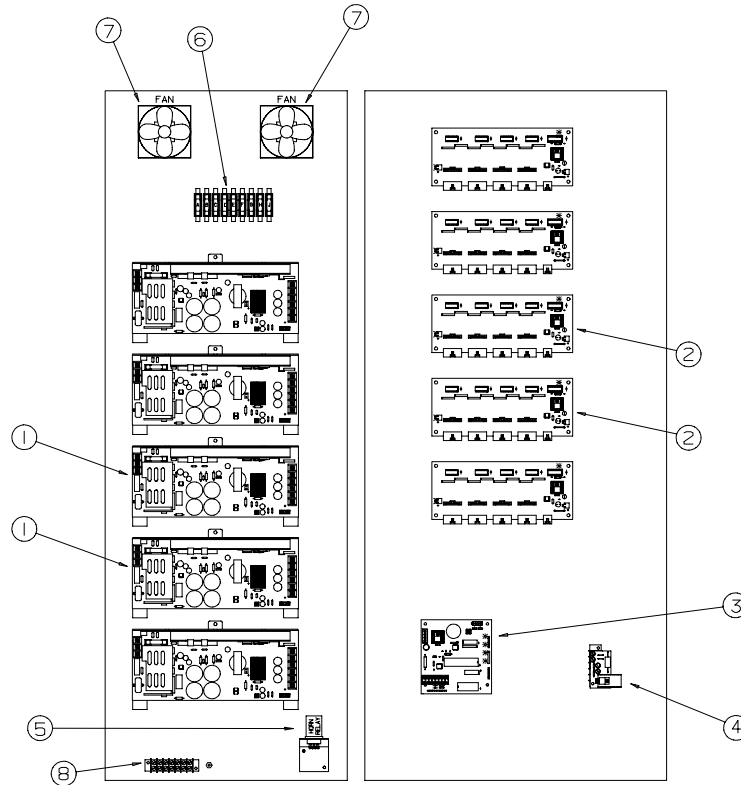

figure 2

CONTROLLER ASSEMBLY

REPLACEMENT PARTS LIST (MP-7479) Controller Assembly				
fig. & index	MFG PART NUMBER	DESCRIPTION	REF DES	VENDOR PART #
2-	152101	Controller Assembly MP-7820	A2	000000
2-1	BL00059P	Power Supply, 24V/300W	A10-15	BL00059P
2-2	EL00852P	Driver PCB Assembly, MP-5000	A4-8	EL00852P
2-3	EL00863P	Receiver PCB Assembly, MP-5000 *** PROGRAM 3MP-CNT-V00***	A3	EL00863P
2-4	152000	Voltage Reduction PCB Assembly	A19	152000
2-5	EL00525P	Relay, 12 VDC DPDT 10 Amp Contact	K1	EL00525P
2-6	701011	Fuse, 5A 250V	F1-F8	MTH-5
2-7	EL00551P	Fan, 24V/40CFM 3"		EL00551P
2-8	701137	Terminal Block, 5C	TB1	670-5

6. DIAGRAMS

6.1 Control Console Keyboard and Slipsheet Layout

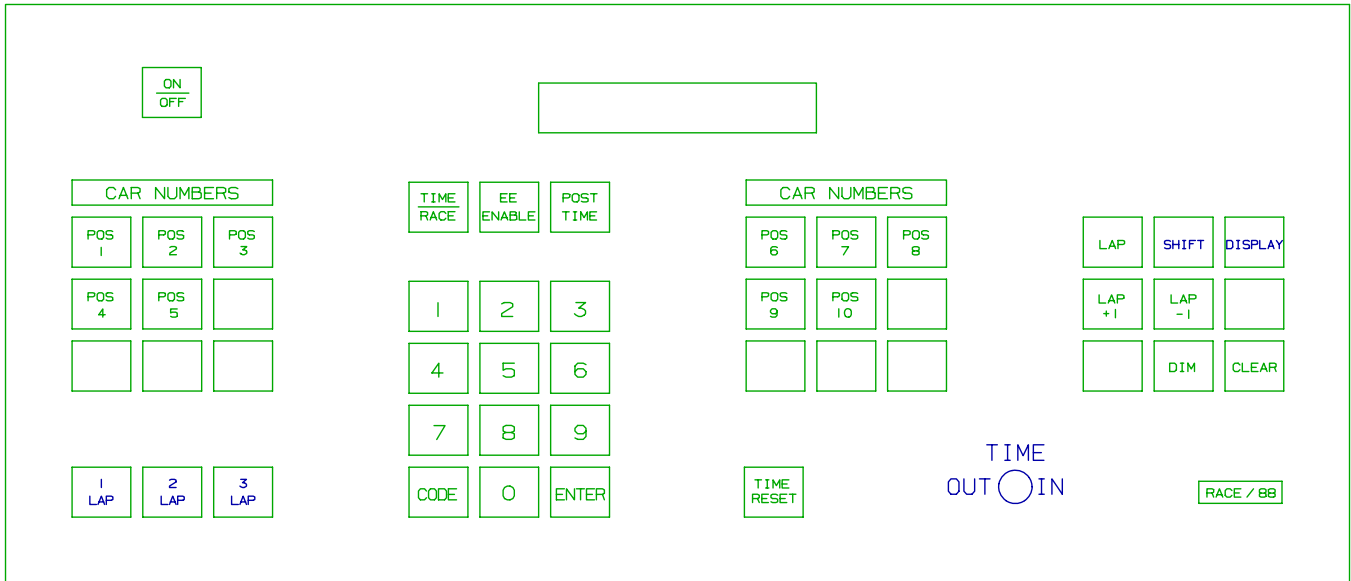

CONSOLE KEYBOARD

6.2 Scoreboard System Layout

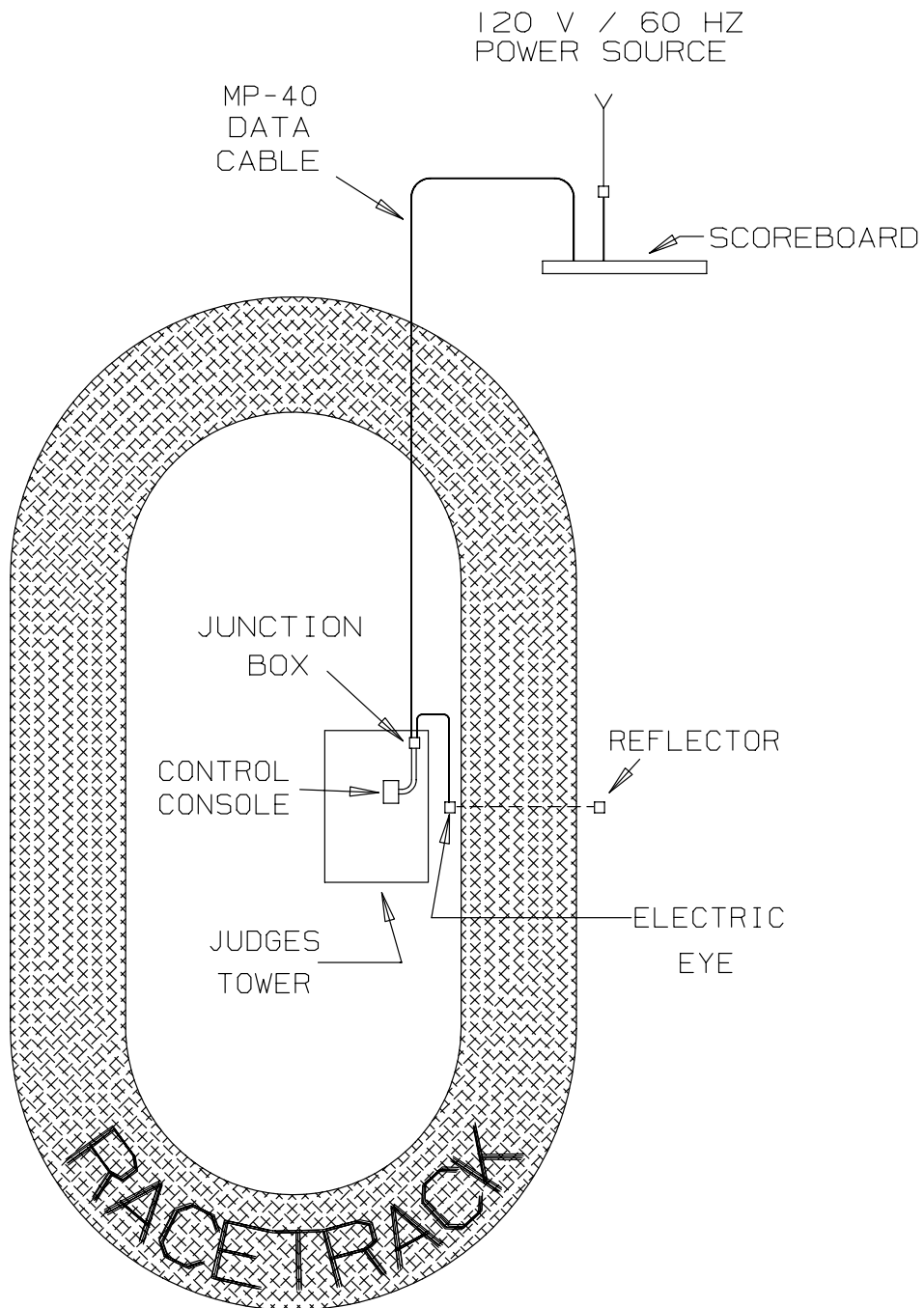

SYSTEM LAYOUT

6.3 Power Wiring

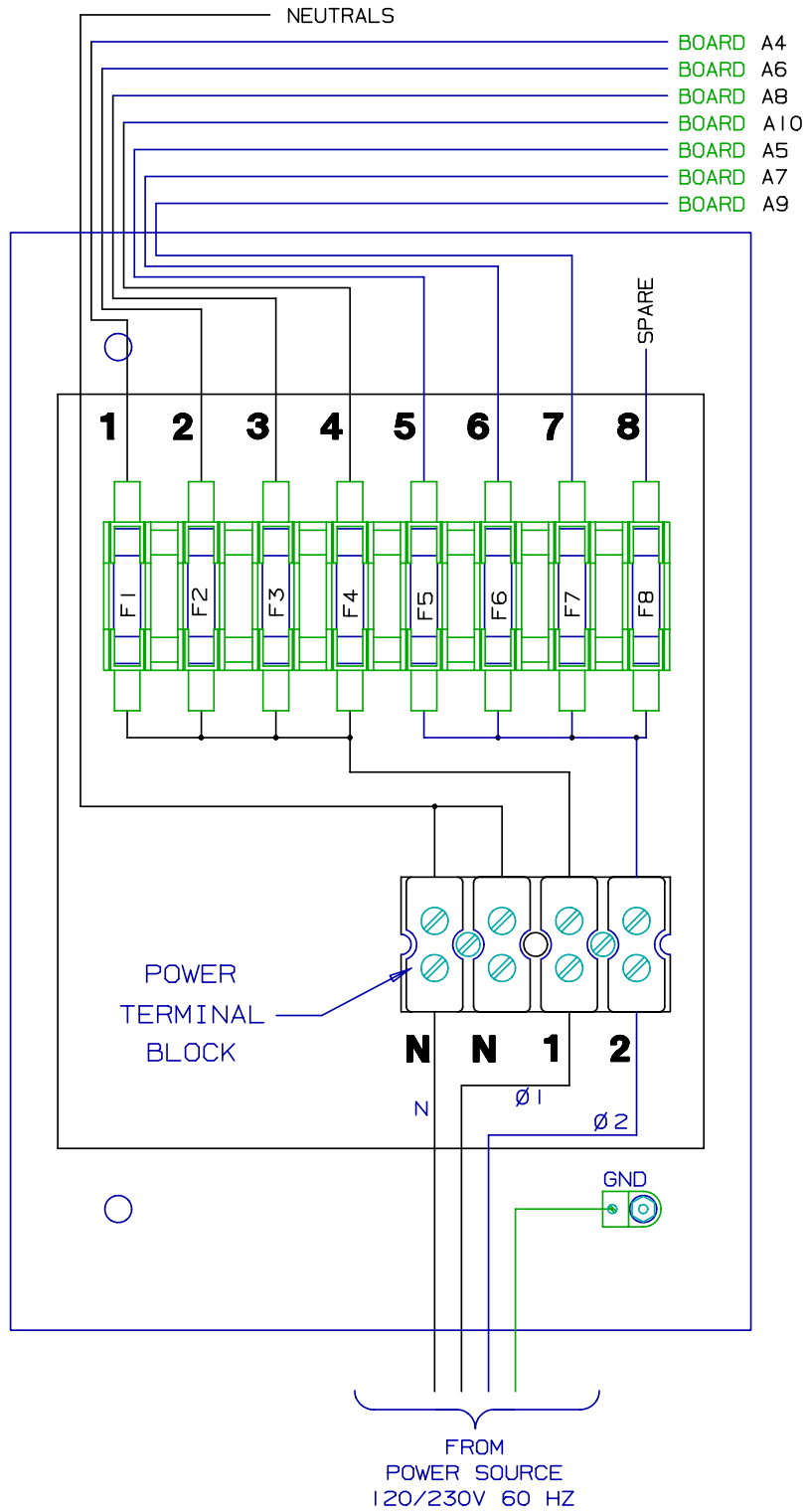

POWER WIRING

6.4 Scoreboard System Layout

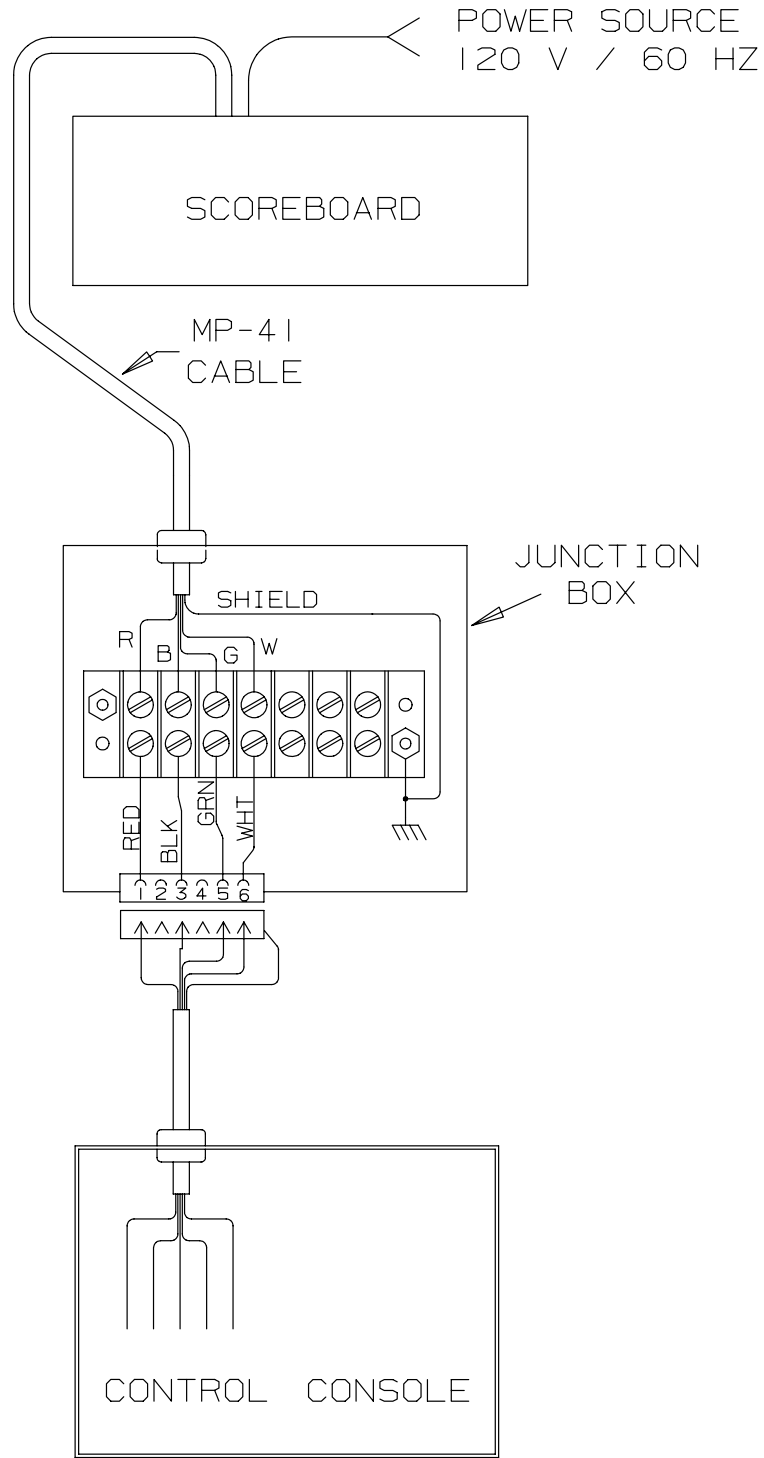
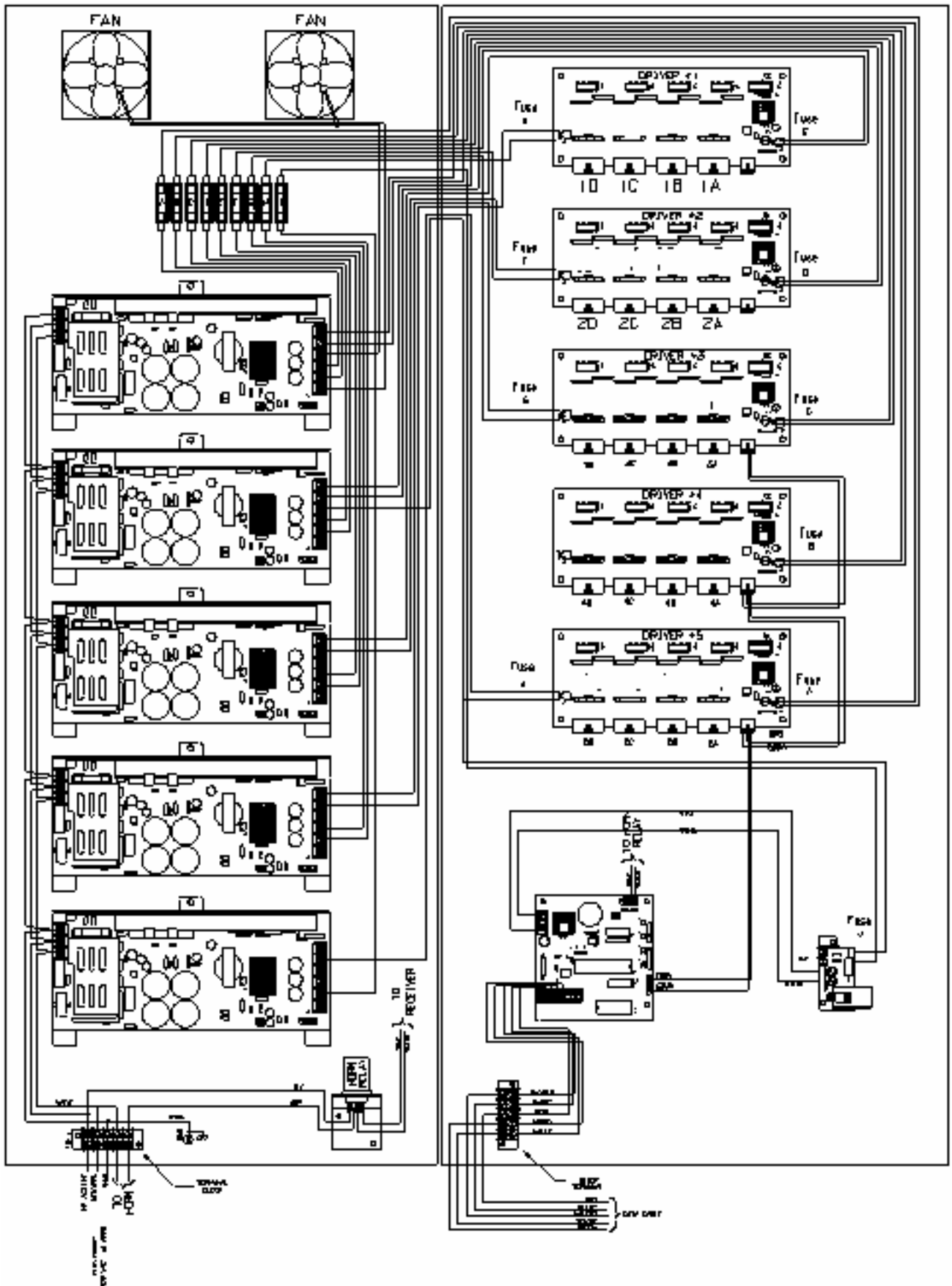

figure 4

SYSTEM LAYOUT

6.5 Controller Assembly Wiring



CONTROLLER ASSEMBLY

6.6 Installation Drawing

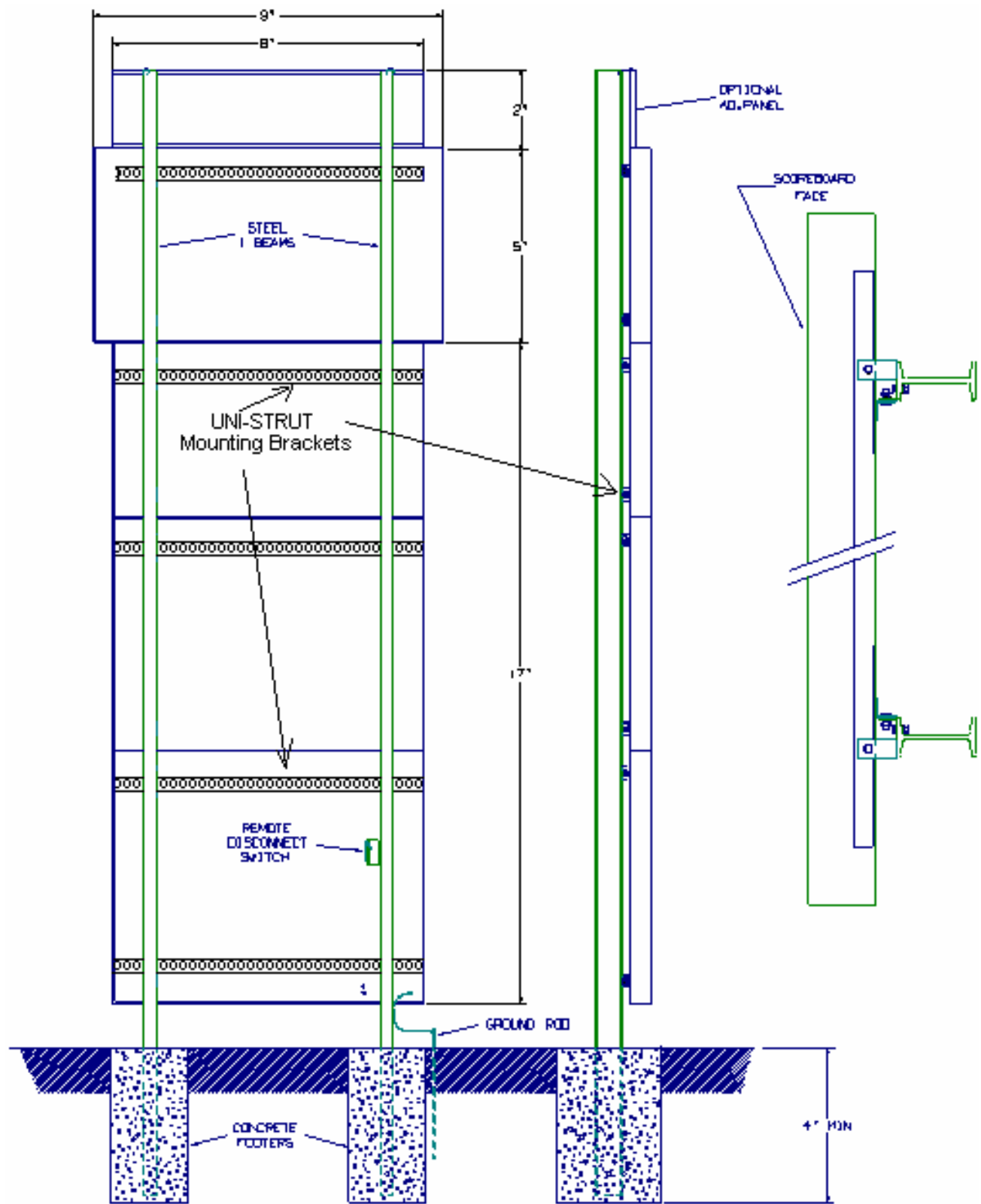

6.7 Installation Drawing Cont. (UNI-STRUT Mounting Brackets)

