



OPERATING INSTRUCTIONS AND SERVICE MANUAL

SOCCER SCOREBOARD

MODEL MP-7476 WITH MP-5000 CONTROL

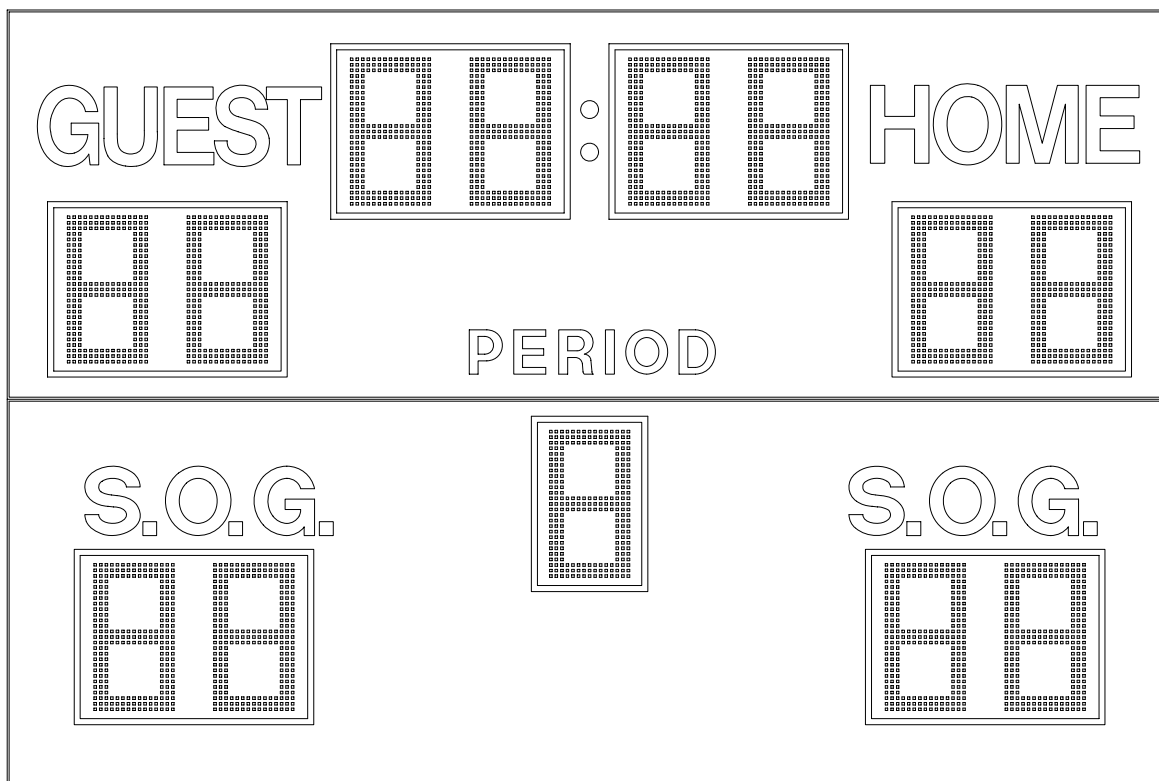

TABLE OF CONTENTS

1. General Information

- 1.1 Description
- 1.2 Identification
- 1.3 Damage
- 1.4 Damage Claim Procedure

2. Installation

- 2.1 General Information
- 2.2 Installation
- 2.3 Electrical Connection

3. Control Console Operation

- 3.1 Scoreboard Power
- 3.2 Control Console Display
- 3.3 Control Console Power
- 3.4 Initializing Scoreboard
- 3.5 Time Setting and Control
- 3.6 Team Scores
- 3.7 Horn (Optional)
- 3.8 Shots on Goal, and Period
- 3.9 Dimmer
- 3.10 Track Operation

4. Maintenance and Troubleshooting

- 4.1 Introduction
- 4.2 Test Equipment
- 4.3 Troubleshooting
- 4.4 Troubleshooting Guide

5. Replacement Parts List

- 5.1 Scoreboard Display Parts
- 5.2 Controller Assembly

6. Diagrams

- 6.1 Control Console Keyboard Layout (Slipsheet)
- 6.2 Scoreboard Layout with Floating Time Control
- 6.3 Power Wiring
- 6.4 Controller Assembly Wiring and Layout
- 6.5 Microprocessor 5 x 9 Lamp Pattern (8 Bit)
- 6.6 Figuregram Wiring Diagram
- 6.7 Installation Drawings

1. GENERAL INFORMATION

1.1 DESCRIPTION

Your All-American scoreboard has been carefully inspected and tested before leaving the factory. It is possible, however, that components may be loosened or forced out of adjustment in transit. If this occurs, follow the troubleshooting guide (section 4). If equipment then fails to operate, contact immediately:

ALL-AMERICAN Service Department
EVERBRITE LLC
P.O. Box 100
Pardeeville, WI 53954
Telephone: (608) 429-2121
Toll Free: 800-356-8146
score@everbrite.com

Parts being returned for repair are to be sent to:

ALL-AMERICAN Service Department
EVERBRITE LLC
401 S. Main Street
Pardeeville, WI 53954

NOTE

If you need to send parts in for repair, please call the ALL AMERICAN service department for a returned goods authorization (RGA) number.

1.2 Identification

ALL-AMERICAN uses a serial number for scoreboard identification. The serial number tags are located on the back of the control console and the lower right hand corner on the face of the scoreboard display. When contacting the factory for assistance it is important that the model number and serial numbers are known.

1.3 Damage

Upon receipt of scoreboard, check for visible damage. If this occurs, or if damage is found after shipment has been accepted, follow the damage claim procedure.

1.4 Damage Claim Procedure

An instruction sheet is enclosed advising the consignee in case of damage in transit. If damage is noted at the time of delivery, consignee must obtain an 'Inspection of Bad Order' from the delivering carrier. In order to process your claim, this must be properly

filled out with a complete statement of all damage and it must be signed by the carrier.

If damage is discovered after delivery, you should call the delivery company. Have them make out a Concealed Damage Report. Fifteen days after delivery are allowed, so this should be done promptly or it is impossible to process this claim.

Advise EVERBRITE corporation of necessary replacement parts, or repairs. Consignee will be invoiced and then should file a claim with the carrier to recover charges. To file your claim follow this procedure:

- (A) Cost of replacement parts or repair charges are invoiced to the carrier by the consignee.
- (B) The following documents, properly filled out, plus invoice, are forwarded to the trucking company in support of your claim:
 - (a) Original bill of lading
 - (b) Original paid freight bill
 - (c) Certified copy of original invoice
 - (d) Standard form for presentation of loss and damage claim

2. INSTALLATION

2.1 General Information

Shipping papers accompany each scoreboard. Check carefully to see that you receive the following:

- 1 ea Soccer Display (2 Pieces)
- 1 ea Control Console
- 1 ea Service Manual
- 1 ea Mounting Hardware Package
- ? ft. control cable (if ordered)
- 1 ea Horn (if ordered)

2.2 Installation

Select the location best suited for visibility by the majority of spectators. Preferred position is facing east or north to avoid direct sunlight on the face of the scoreboard, if day games are played.

For permanent mounting to uprights, see the enclosed installation drawing in section 6.

Consult Section 6 for junction box and scoreboard wiring.

2.3 Electrical connections

The MP-7476 scoreboard requires one 120 VAC 20 AMP circuit.

IMPORTANT !!!

To protect the control from damage, it is advisable to disconnect the control and store in a dry secure area when not in use.

NOTE

This equipment is **UL** and **NRTL** approved and complies with the requirements in part 15 of the FCC rules for a class A computing device. Operation of this equipment in a residential area may cause unacceptable interference to radio and television reception, requiring the operator to take whatever steps are necessary to correct the interference.

3. CONTROL CONSOLE OPERATION

3.1 Scoreboard Power

Turn on the branch circuit to the scoreboard. The Home and Guest scores will show "0".

3.2 Console Display

The Liquid Crystal Display module displays the scoreboard information entered from control console. The following information is displayed continuously: Time, Home and Guest scores, Shots on Goal, Period, and Auto Horn Enable.

3.3 Console Power

Plug the control console into the Press Box Junction Box.

Push **ON/OFF** once to turn the console on.

Push **ON/OFF** a second time to shut the console off.

When first turned on; the console display should show as follows:

MULTI-SPORT CONTROL
MP-7000 V 2.00.A 2003

3.4 Initializing Scoreboard

Enter the two digit code (**16**) shown in the lower left corner of the keyboard as in

the following example: Push **CODE** **1** **6** **ENTER** .

When the proper code has been entered, the console display will show as follows.

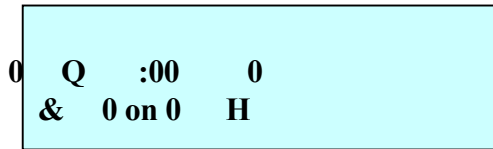

The scoreboard display will now show :00 in the time section.

3.5 Setup

The **SETUP** key will step through a list of options.

Press **YES/NO**, or make Numeric Entries to make changes.

Pushing **ENTER** without any other input skips to the next item.

Pushing **CLEAR** exits setup, and all changes are kept.

Accurate time will be kept without power to the scoreboard for up to 2 months.

Select brightness level for the scoreboard digits by pushing 1-8 and **ENTER**.

Select game time period. Example, 800 and press **ENTER** for 8 minutes.

Select time outs allowed. Example, 3 and press **ENTER** for 3 time outs.

Select automatic horn for end of period. Example, Yes/No and press **ENTER**.

Select set time of day clock. Example, press **2** **1** **5** **ENTER** for 2:15.

The scoreboard will display the time of day after game time use, if desired.

Accurate time will be kept without power to the scoreboard for up to 2 months.

3.6 Timing

The main game time period is set in the "SETUP" program, however this time period may be changed or edited using the **EDIT TIME** key.

To change the period time; Push **EDIT TIME**, the desired time, then **ENTER**.

To reset the period time to the original setting; Push **TIME RESET**.

To change the time period directional mode for counting up or down; Push **UP/DOWN**.

When in the Up mode, an arrow up symbol is displayed next to the time on the LCD display. If in the Down mode, there is no arrow displayed.

3.7 Team Scores

The Home and Guest Scores can be changed in three different ways.

- (A) To add 1 to the existing score: Push **+1**.
- (B) To directly enter or correct a score: Push Home or Guest **SCORE**, followed by the desired number, then **ENTER**.

Example: Present Home Score is 15. Change the score from 15 to 23.

Push: Home **SCORE** **2** **3** **ENTER**.

- (C) To clear the score: Push **SCORE** **CLEAR**.

3.8 Horn (Optional)

The horn will blow for 1/2 second each time **HORN** is pressed.

The horn will blow automatically at the end of each period for 2 seconds.

The automatic horn function may be disabled by using the **AUTO HORN** key.

An 'H' is displayed on the LCD when this function is enabled.

3.9 Shots on Goal, and Period

Entries to the above function is made in the same manner as direct entry for Team Scores.

3.10 Dimmer

Push **DIMMER** to dim the lamps during night use.

3.11 Track Operation

For track operation, use Code 82. The timer will now count up from zero. When in the track mode, the console LCD will display two timers. If you want to know the split times push

SPLIT. The bottom timer will stop so that you can read the time. Now if you

push **RESUME**, the timer will show what the top timer shows, and resume timing.

The 1/10 second digit will work with the track code but not with the football code.

4.0 MAINTENANCE AND TROUBLESHOOTING

4.1 Introduction

This section gives maintenance and troubleshooting information. Included are troubleshooting guides for typical scoreboard malfunctions. If the cause of a problem cannot be determined, please contact the Customer Service Department.

4.2 Test Equipment

A simple analog or digital voltmeter will be sufficient for all user repairable problems. Printed circuit boards requiring troubleshooting should be returned to the factory.

4.3 Troubleshooting

Whenever possible, follow the troubleshooting guides prior to contacting the Customer Service Department. If a problem not described in the guides exists, contact the customer service department immediately. Read through the appropriate troubleshooting section before beginning a repair. Refer to the diagrams in chapter 6 as an aid in troubleshooting scoreboard malfunctions.

4.4 Troubleshooting Guides

(A) Scoreboard doesn't light and console doesn't work:

- (a) Check that the main power switch is turned on and providing power to the scoreboard.
- (b) Check to see that the green Led is lit on each power supply.
- (c) Check for 24 VDC at the power supply terminals.
- (d) Check the 110 VAC power connections and voltages at the scoreboard.
- (e) Replace any defective or blown fuses.
- (f) Check for 12 to 16 VDC on the red and black wires at the data cable terminal block.
- (g) Contact the Customer Service Department.

(B) Scoreboard digits

- (a) Check all connections.
- (b) Turn the main power "on".
- (c) If the scoreboard still doesn't light, check the items in section (A), power supply voltage and fuses.
- (d) Check if LED D1 on the receiver board is lit. If not, check that the receiver board is plugged into the power supply board, then contact the customer service department.
- (e) Check to see that the LED on the first driver board (closest to receiver) is flashing. If not, check the data cable connections (orange and grey wires) from the receiver to the drivers, and check to be sure that the power connection to the driver board is OK.
- (f) If the driver board LED is still not flashing, connect a different driver board to the receiver (first in line). If the LED is now flashing, the first driver board should be replaced. Otherwise the problem is on the receiver board.

(C) The scoreboard digits light but the console doesn't work.

- (a) For a cable connected system, check for 12 to 16 VDC between the red and black wires in the junction box. For wireless consoles, check the output of the wall transformer by unplugging it from the console, putting the + meter lead into the center cavity of the power plug and touching the meter lead to the metal shell. The reading should be at least 10 VDC.
- (b) If the voltage is 10 V or more, turn on and code in the console, even though it may not appear to be working. Listen for beep sounds when pressing the keys, and see if the scoreboard responds at all. If the scoreboard is radio controlled, go to section D, step 3.

Otherwise contact customer service with results or see Advanced Troubleshooting, in section C.

- (c) If the voltage from step 1 is zero, measure the voltage on the red and black wires at the terminal block inside the scoreboard. If the voltage is still zero, go to section A, step 3. Otherwise check the cable to the junction box for continuity.
- (d) Refer to advanced troubleshooting, section B to connect the console directly to the receiver board.

(D) The scoreboard digits light, the console works, but there is no control of the scoreboard.

- (a) If the scoreboard is a hardwired system, check for 1 to 4 volts AC on the green and white wires at the junction box (console on and coded in). Then go to step 6.
- (b) With wireless consoles, be sure that the battery (if so equipped) is fully charged, or better still, use the wall transformer to power the console.
- (c) Check the LED on the radio adapter board inside the scoreboard. If it is lit, turn the console off. This LED should go out about 5 seconds later. Turning the console on again should relight the LED.
- (d) Bring the console within 10 to 25 feet of the scoreboard and test again. If the radio adapter LED now works, check and tighten antenna connections as necessary, both in the scoreboard and in the console. CAUTION: the antenna connection at the radio can be easily broken. Push or pull the connector STRAIGHT on or off!
- (e) Check to see if D1 is lit. If not, check that the receiver board is plugged into the power supply board, then contact the customer service department.
- (f) With the console turned on and coded in, check to see that LED D2 on the receiver board is flashing. If not, refer to Advanced Troubleshooting for instructions on connecting the console directly to the scoreboard or contact customer service.
- (g) Starting with the driver board closest to the receiver, check to see that the LED on each driver board is flashing. If not, check the data cable connections (orange and grey wires) from the receiver to the drivers, and check to be sure that the power connection to the driver board is OK.

(E) The scoreboard works, but some lights stay on all the time

- (a) With the main power "OFF", disconnect (and tag) the suspect digit from the driver board. Plug a known good digit into that position on the driver card. Do Not Plug the Suspect Digit into any other location!
- (b) Turn the power back on. If the good digit shows the same problem as the original digit, there is a problem on the driver PCB assembly. See the original digit, replacement parts list for the proper replacement part or refer to Advanced troubleshooting, section A to swap another driver board into that position. There may also be a problem with the digit or its cabling, continue with step 3.

- (c) Check the digit and cable assembly for shorts to the scoreboard frame and to the + and - power leads.
 - (d) Plug the suspected bad digit into another output position. USE the SAME driver board (A bad digit may be the cause of a driver board failure). If the same lights remain on, replace the digit and driver board.
- (F) The scoreboard works, but some lights do not come on.
- (a) If only part of a digit works, e.g. a 0 looks like a U, go to step 6.
 - (b) If one or more of the digits are completely blank, check the LED on the corresponding driver board.
 - (c) If the LED is blinking, check the power connection at the opposite end of the board for 24 VDC. If not, check the power and data cable connections on the driver board.
 - (d) Plug the blank digit into a known good driver board position. If it is still blank, check for broken wires or bad connections in the digit cable. Replace the digit if the cabling is OK.
 - (e) If the digit now works, see the replacement parts list for the proper replacement driver board or refer to Advanced troubleshooting, section A to swap another driver board into that position.
 - (f) Disconnect the suspect digit and plug a known good digit into that driver location.
 - (g) If the good digit shows the same problem, see the replacement parts list for the proper replacement driver board or refer to Advanced troubleshooting, section A to swap another driver board into that position.
 - (h) If the good digit is working, check for a broken wire or bad connection on the 10 pin connector.
 - (i) Contact customer service for the proper replacement digit.

4.5 Advanced Troubleshooting

In emergency situations (Tournament begins in an hour), the following steps may help to make the scoreboard usable in a temporary fashion. These procedures are best performed by someone that has experience working on electronic equipment. If possible, consult with customer service before proceeding.

- (A) All of the driver boards in a 7000 series scoreboard are interchangeable. However, each board has an address programmed inside its microcontroller chip. The chip from the board being replaced must be put into the new board for proper operation. Example: The scoring driver of a football board has a problem. The Ball On/Yards To Go driver can be used in its place. (Ball on and yards to go will not be usable until a new driver board is received from the factory).
 - (a) Remove power from the scoreboard.
 - (b) Take the bad driver board out and set it aside. Put the replacement driver in position.
 - (c) Remove the processor chip from the new driver.
 - (d) Carefully take the processor chip out of the old driver board and install it in the replacement board. Be sure the notched end of the chip is aligned correctly.
 - (e) Put the processor chip from the new board into the defective driver board so it doesn't get lost.
 - (f) Reconnect power, data, and the display cables to the new driver board.
- (B) Direct connection of consoles to scoreboards can be done to ensure that the

electronics is working properly. For radio controlled systems, skip to step 8.

- (a) For a hardwired system, the cover of the junction box with the connector and wire pigtail can be used. Open the junction box and disconnect the connector wires at the terminal block.
- (b) Take the cover plate/connector assembly up to the scoreboard. Attach the red and black wires to the matching positions on the terminal block. Disconnect the red and black data cable wires (that go to the junction box).
- (c) Attach the green and white wires from the cover plate connector to the terminals on the lightning protector board where the same colored wires connect to the receiver board.
- (d) Disconnect the data cable (to the junction box) green and white wires from the lightning protector board. Mark the board so that the wires can be put back on the correct terminals.
- (e) Test the system. If it works, move the green and white wires from the cover plate connector to the other two terminals on the lightning protect board.
- (f) Test again. If the scoreboard works, there is a problem in the data cable somewhere between the scoreboard and the junction box. If not, the lightning protector board must be replaced.
- (g) The data cable can be checked by re-installing the junction box cover plate and connecting both green wires to one of the green wire terminals on the lightning board, and doing the same with the white wires. While the scoreboard will operate with the lightning protect board bypassed in this fashion, it should be fixed as soon as possible, since the board also protects the electronics in the scoreboard from other sources of potentially damaging interference.
- (h) Radio controlled consoles may be connected directly to the scoreboard through the 12 pin radio connectors. Remove the radios and interface boards.
- (i) Using 22 gauge solid wire, connect pin 10 of the console connector to pin 10 of the scoreboard receiver board connector. Also connect pin 2 of the console connector to pin 6 on the receiver board connector.
- (j) Powering the console from the battery or wall cube, the system should operate. This eliminates any radio related communication problems.

NOTE !: if it is necessary to operate the scoreboard this way, keep the 2 wires as short as possible (10 ft. max), since there is no protection on these lines and

(C) Console problems

- (a) Power is OK, but console does not turn on: check that the keypad connector is plugged into the main board in the console.
- (b) Console beeps, but has no display: check the ribbon cable between the main console board and the display module.
- (c) Erratic operation, abnormal display: check the socketed IC chips to be sure that they are well seated.

5. REPLACEMENT PARTS LIST

5.1 Scoreboard Display Parts

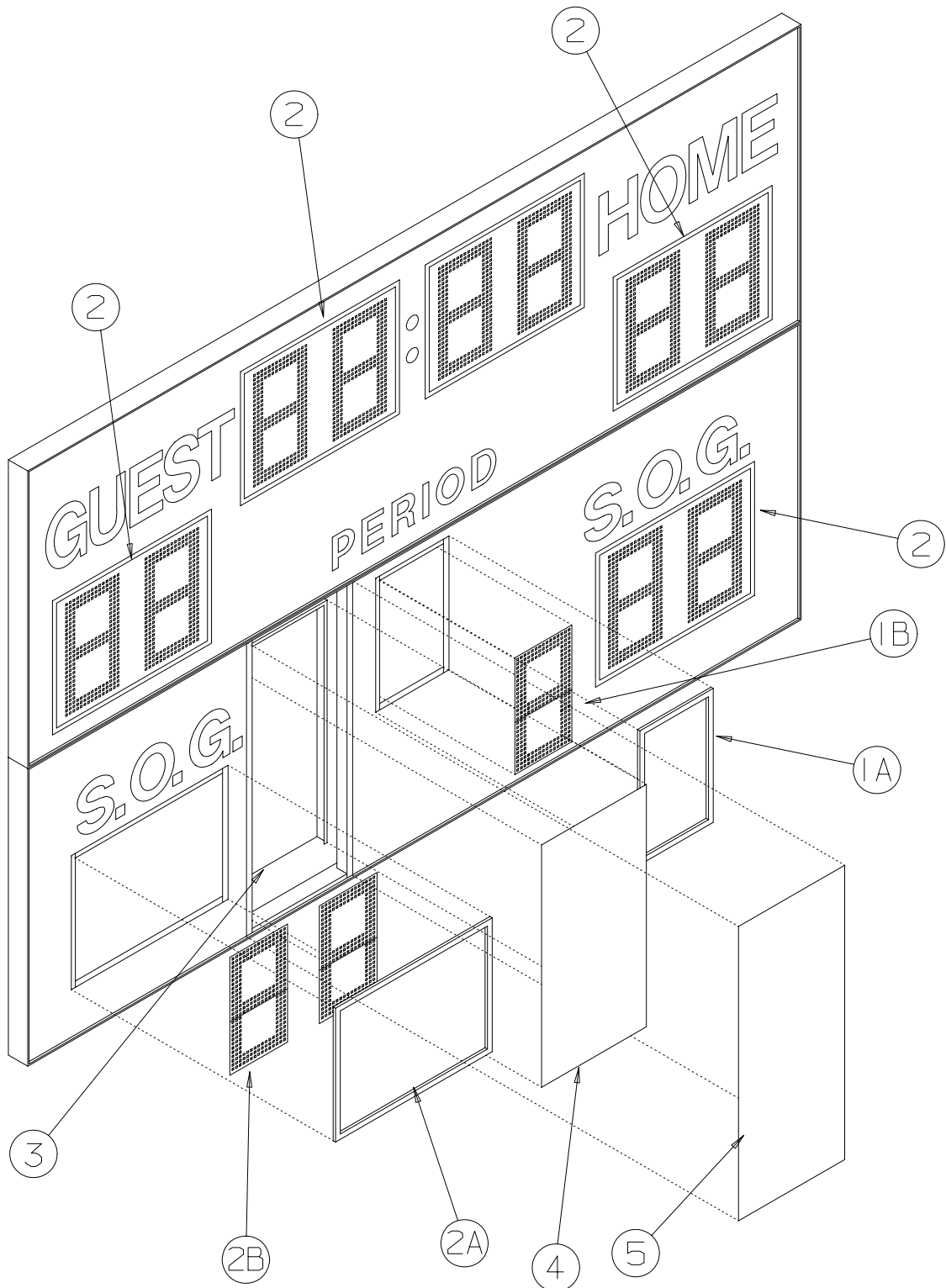

figure 1

DISPLAY ASSEMBLY

REPLACEMENT PARTS LIST (MP-7476)

fig.& index	MFG PART NUMBER	DESCRIPTION	REF DES	VENDOR PART #
1-	152002	Display, top		152002
1-	151978	Display, bottom		151978
1-1A	000000	Window Assy, single digit 18"		
1-1B	000000	Digit, 18" Red		
1-1Ba	000000	Digit Part A		EL00737P
1-1Bb	000000	Digit Part B		EL00738P
1-2A	152021	Window Assy, double digit 18"		
1-2B	000000	Digit, 18" Red		
1-3	000000	Controller Assembly, W/ 3 Drivers *****SEE DETAIL FIGURE 2*****	A2	000000
1-4	000000	Rain Shield		000000
1-5	000000	Service Door		000000
	151735 151684 151692	Control Console Slipsheet Pair Transmitter PCB Assembly ***** PROGRAM MP5000 V2.12 *****	A1	151735 151684 151681
	SW005100	Toggle Switch,	S1	SW005100
	151740	Cable Assy, 25'		151740
	930894	Connector, 6 Pin Male Cable	P1	RM12BPG6P
	EL057700	LCD Display, 2 Line 20 Character		
	151682	Keyboard Assembly,		151682
	WH009100	Ribbon Cable Assembly, 14C 8"		WH009100
	122763	Enclosure,		
	151915 151073 930895 150508	Press Box Junction Box, 7000 series Plate, Connector Mounting Connector, 6 Pin Female Cable, MP-40 Control	J1	151915 151073 RM12BRD-6S YR21233

5.2 Scoreboard Controller Assembly Parts

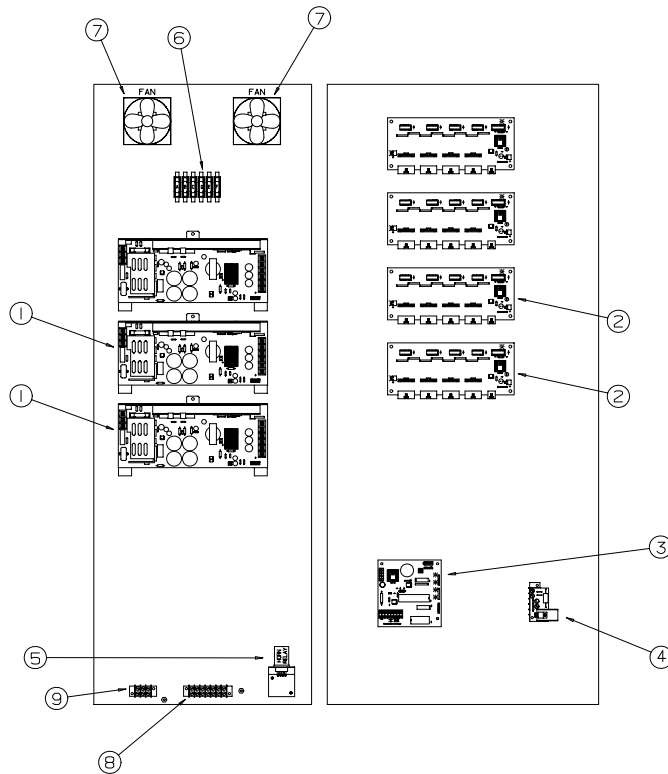

figure 2

CONTROLLER ASSEMBLY

REPLACEMENT PARTS LIST (MP-7476) Controller Assembly				
fig.& index	MFG PART NUMBER	DESCRIPTION	REF DES	VENDOR PART #
2-	000000	Controller Assembly	A2	000000
2-1	BL00059P	Power Supply, 24V/300W	A10-A12	BL00059P
2-2	MM00598P	Driver PCB Assembly, 4 Position	A4-A7	MM00598P
2-3	150635	Receiver PCB Assembly *** PROGRAM 3MP-CNT-V00***	A3	150635
2-4	152000	Voltage Reduction PCB Assembly	A19	152000
2-5	000000	Relay,	K1	000000
2-6	701011	Fuse, 5A 250V	FA-FH	MTH-5
2-7	EL00551P	Fan, 24V/40CFM 3"		EL00551P
2-8	701137	Terminal Block, 7C	TB1	670-7
2-9	701101	Terminal Block, 3C	TB2	670-3
2-10	705723	Spacer, P.C. Board		LCBS-6-01

6. DIAGRAMS

6.1 Control Console Keyboard and Slipsheet Layout

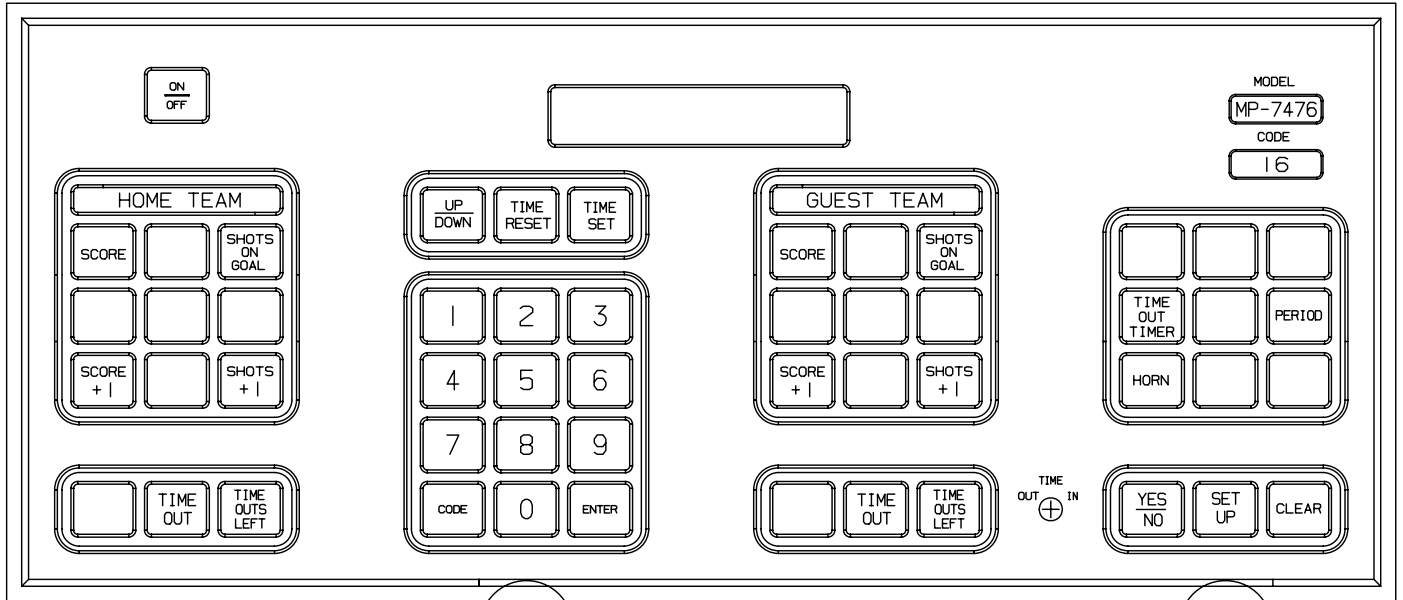

figure 3

CONSOLE KEYBOARD

6.2 Scoreboard System Layout

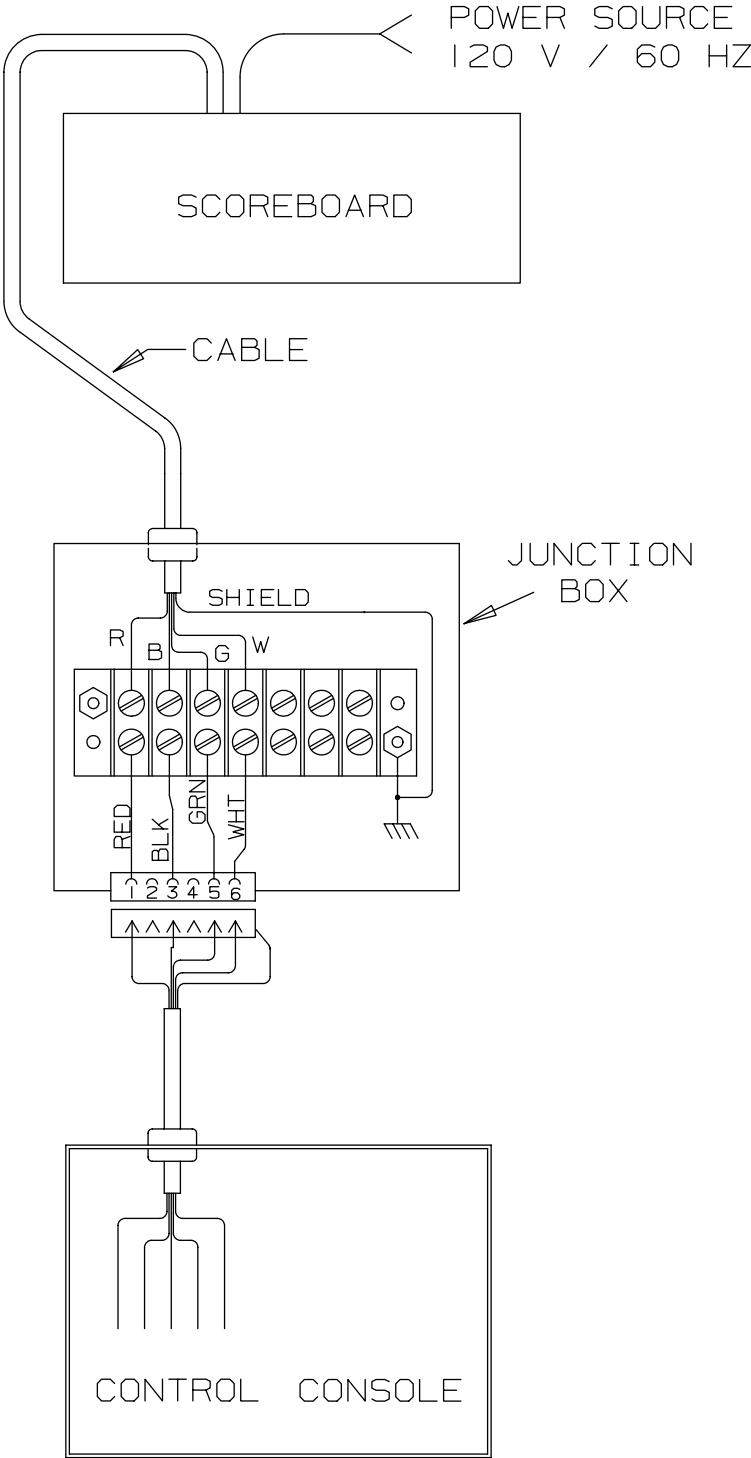
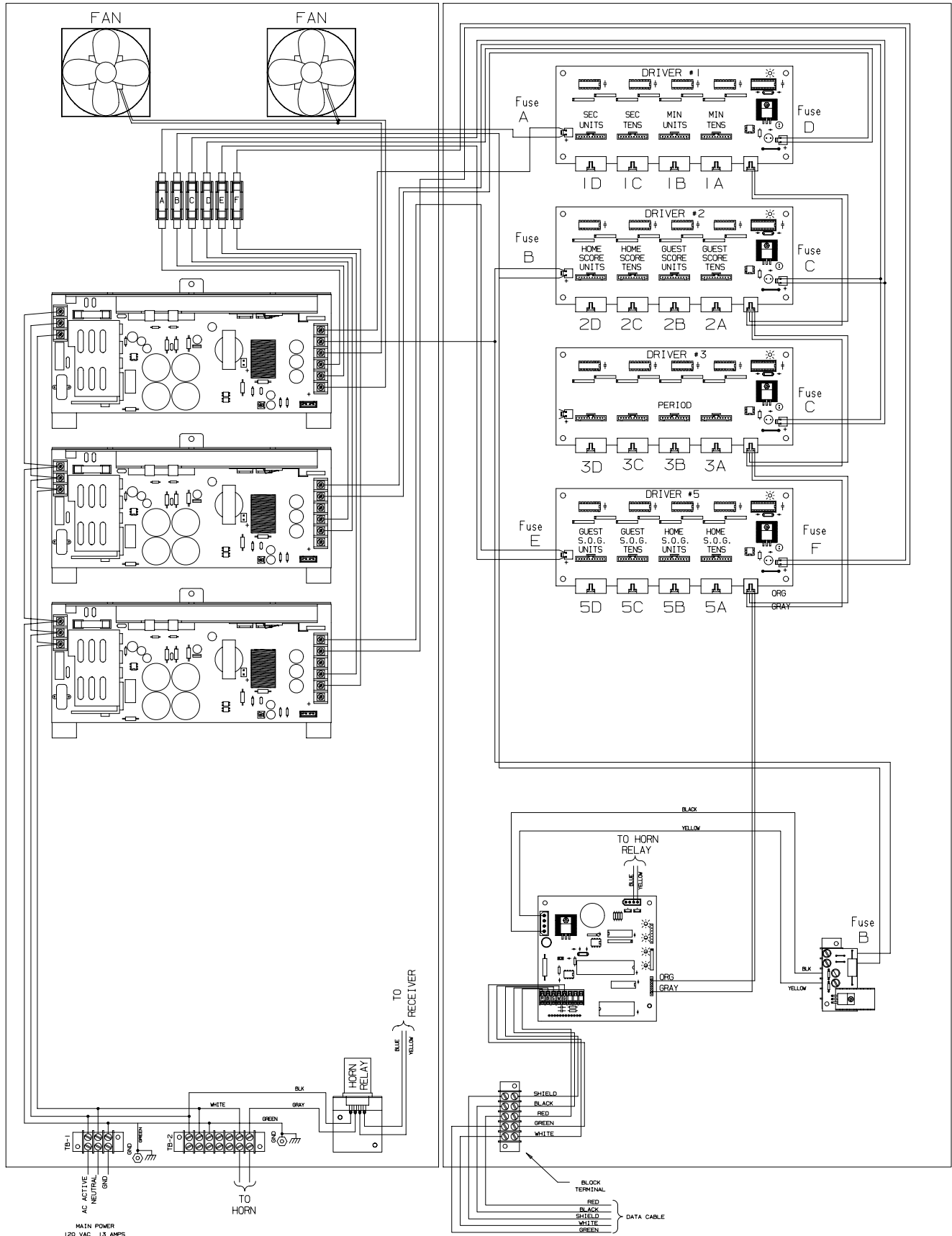

figure 4

SYSTEM LAYOUT

6.3 Controller Assembly Wiring



CONTROLLER ASSEMBLY

6.4 Microprocessor 5 X 9 LED Pattern

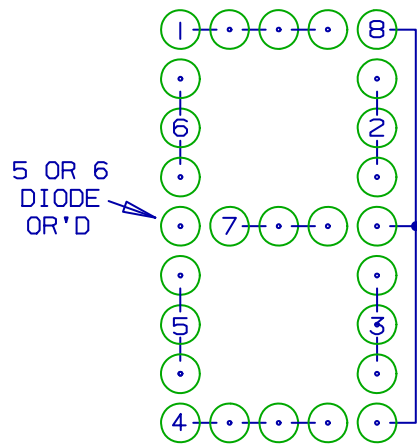
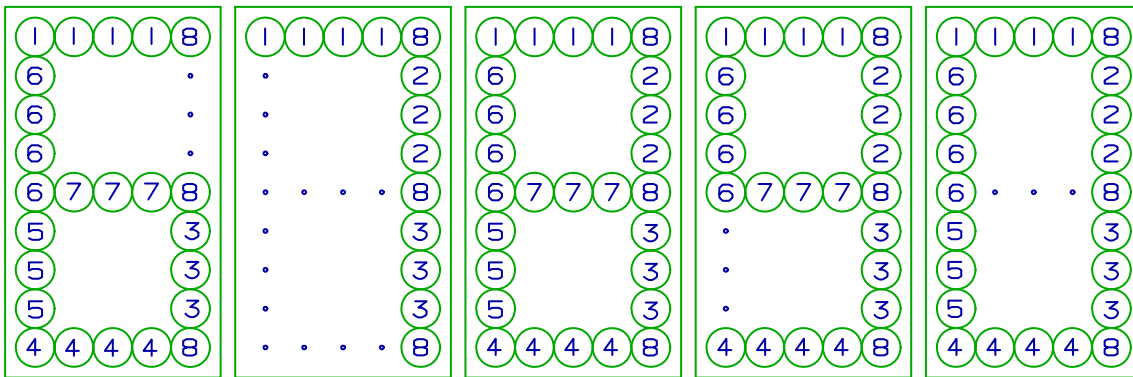
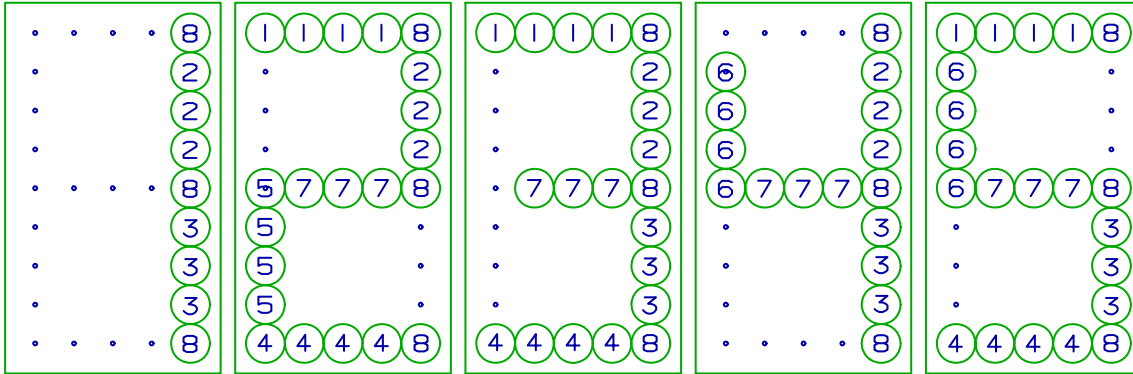

NUMERALS

	0	1	2	3	4	5	6	7	8	9
1	0	.	2	3	.	5	6	7	8	9
2	0	1	2	3	4	.	.	7	8	9
3	0	1	.	3	4	5	6	7	8	9
4	0	.	2	3	.	5	6	.	8	9
5	0	.	2	.	.	.	6	.	8	.
6	0	.	.	.	4	5	6	.	8	9
7	.	.	2	3	4	5	6	.	8	9
8	0	1	2	3	4	5	6	7	8	9

MICROPROCESSOR 5 X 9 (8 BIT) LED PATTERN

6.5 Figuregram Wiring

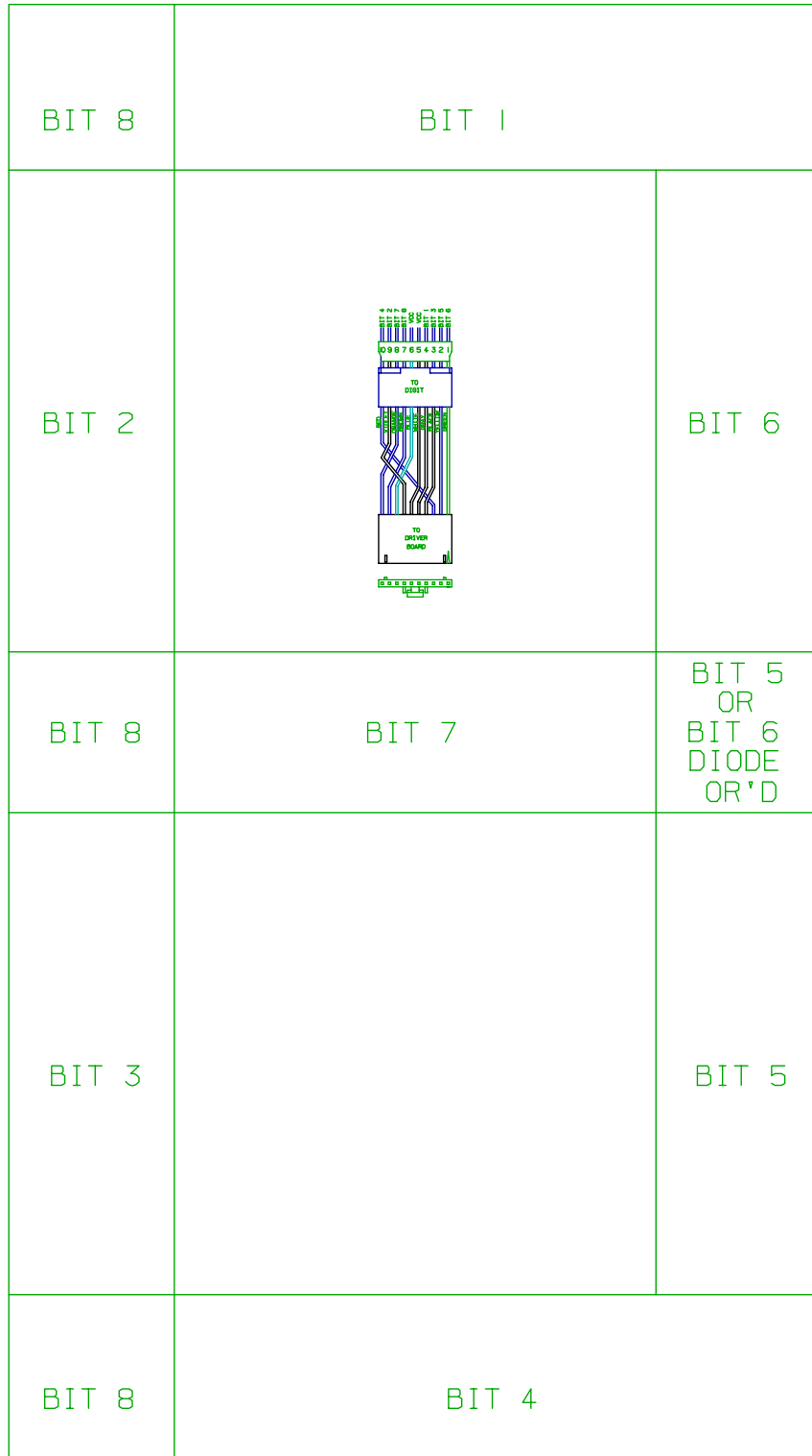

REAR VIEW

FIGUREGRAM WIRING

6.6 Installation Drawing

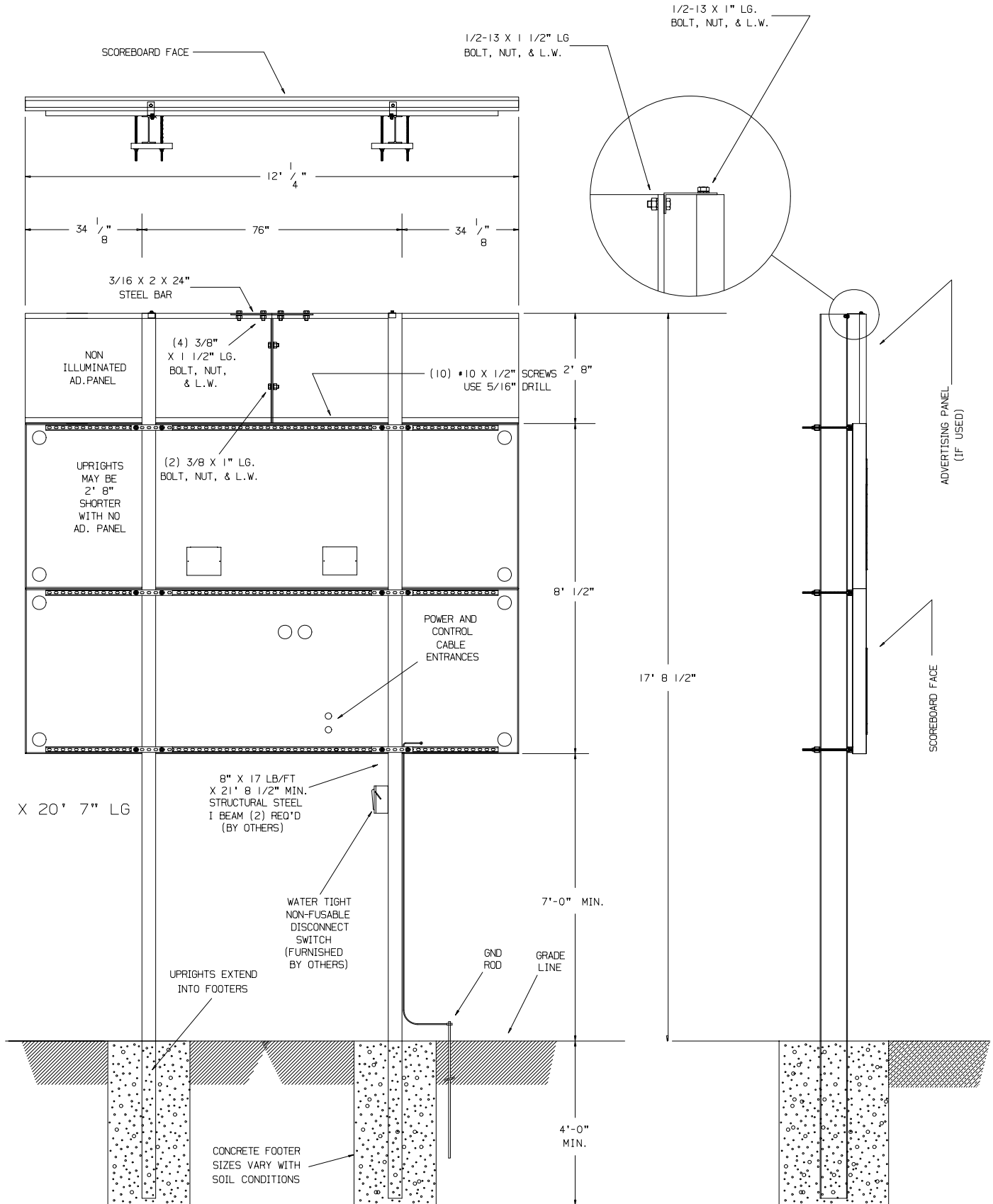

6.6 Installation Drawing Cont.

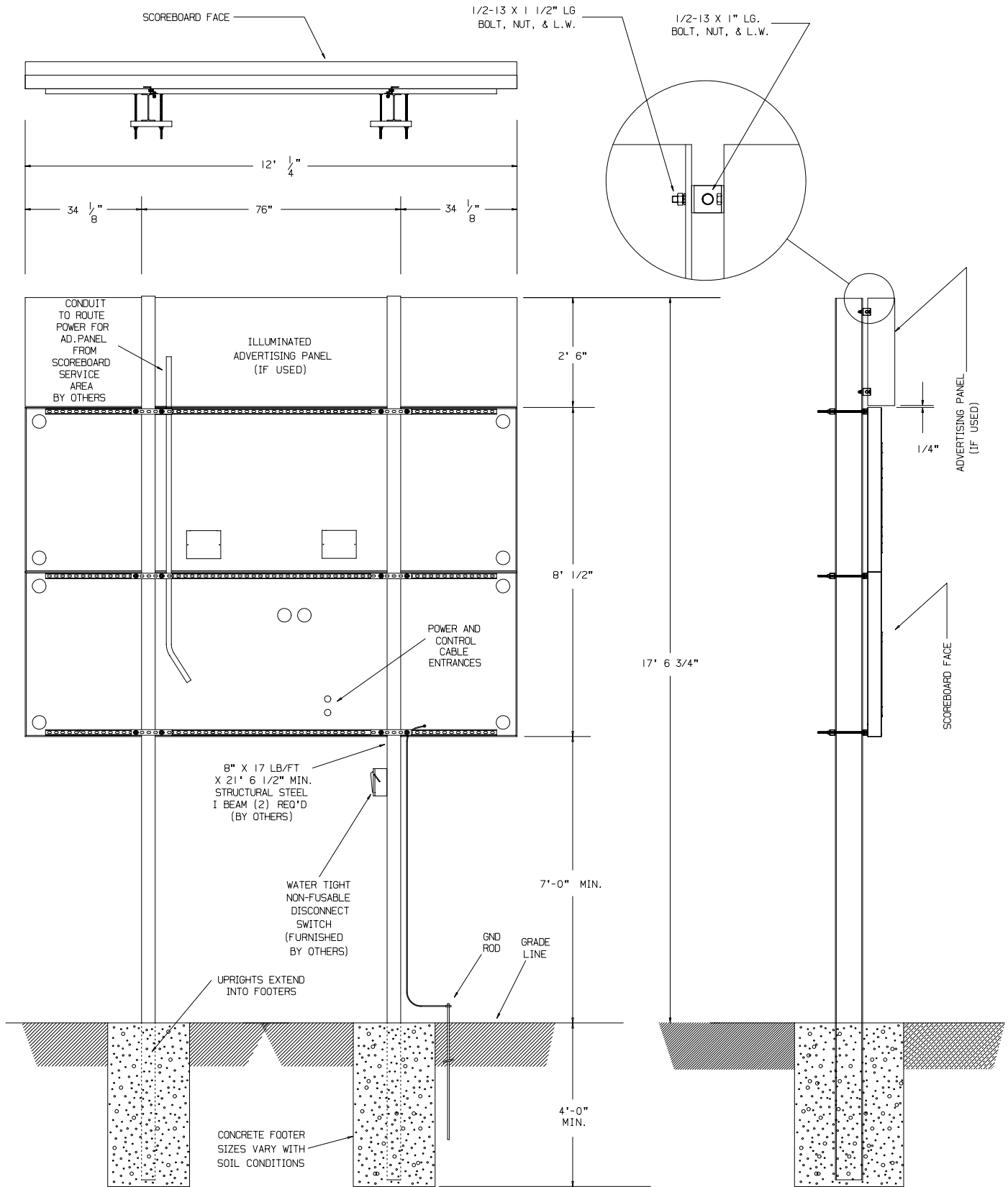

6.6 Installation Drawing Cont.

