

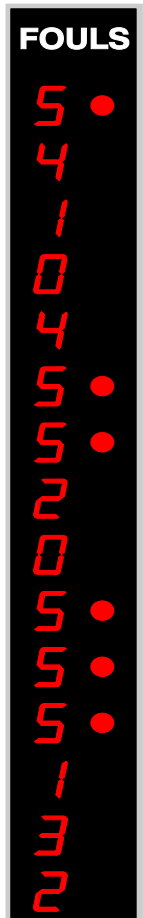

Operating Instructions & Service Manual

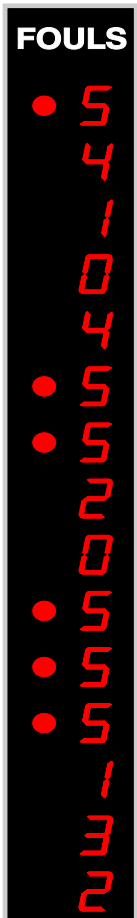

SCOREBOARD

PLAYER FOULS PANELS

Basketball Player Fouls Panels Model MP-5215

TABLE OF CONTENTS

	<u>PAGE</u>
<u>1. GENERAL INFORMATION</u>	3
1.1 DESCRIPTION	
1.2 IDENTIFICATION	
1.3 DAMAGE	
1.4 DAMAGE CLAIM PROCEDURE	
<u>2. INSTALLATION</u>	4
2.1 GENERAL INFORMATION	
2.2 INSPECTION	
2.3 PRE-TEST	
2.4 DATA CABLE INSTALLATION	
2.5 ELECTRICAL CONNECTIONS	
<u>3. CONTROL CONSOLE OPERATION</u>	5
3.1 DISPLAY POWER	
3.2 CONSOLE POWER	
3.3 CONSOLE DISPLAY	
3.4 PLAYER NUMBERS	
3.5 PLAYER FOULS ENTRY	
3.6 PLAYER IN GAME ENTRY/SUBSTITUTION	
<u>4. MAINTENANCE AND TROUBLESHOOTING</u>	7
4.1 INTRODUCTION	
4.2 TEST EQUIPMENT	
4.3 TROUBLESHOOTING	
4.4 TROUBLESHOOTING GUIDE	
<u>5. REPLACEMENT PARTS LIST</u>	10
5.1 FOULS PANEL DISPLAY PARTS	
<u>6. DIAGRAMS</u>	12
6.1 CONTROL CONSOLE KEYBOARD AND SLIPSHEET LAYOUT	
6.2 FOULS PANELS SYSTEM LAYOUT (B-13482)	
6.3 JUNCTION BOX WIRING DIAGRAM (B-121447 & C-13489)	
6.4 FOULS PANEL WIRING	
6.5 INSTALLATION DRAWING (C-13481)	

1. GENERAL INFORMATION

1.1 Description

Your All American Scoreboard has been carefully inspected and tested before leaving the factory. It is possible, however, that components may be loosened or forced out of adjustment in transit. If this occurs, follow the troubleshooting guide (section 4). If equipment then fails to operate, contact immediately:

ALL AMERICAN Service Department
EVERBRITE Corporation
P.O. Box 100
Pardeeville, WI 53954
Telephone: (608) 429-2121
Toll Free: 800-356-8146
E-mail score@everbrite.com

Parts being returned for repair are to be sent to:

ALL AMERICAN Service Department
EVERBRITE Corporation
401 S. Main Street
Pardeeville, WI 53954

NOTE

If you need to send parts in for repair, please call the ALL AMERICAN service department for a returned goods authorization (RGA) number.

1.2 Identification

The serial number tags are located on the back of the control console and the lower right-hand corner on the face of the scoreboard display. When contacting the factory for assistance it is important that the model number and serial number are known.

1.3 Damage

Upon receipt, check for visible damage. If this occurs, or if damage is found after shipment has been accepted, follow the damage claim procedure.

1.4 Damage Claim Procedure

An instruction sheet is enclosed advising the consignee in case of damage in transit. If damage is noted at the time of delivery, consignee must obtain an 'Inspection of Bad Order' from the delivering carrier. In order to process your claim, this must be properly filled out with a complete statement of all damage and it must be signed by the carrier.



If damage is discovered after delivery, you should call the delivery company. Have them make out a Concealed Damage Report. Fifteen days after delivery are allowed, so this should be done promptly or it is impossible to process this claim.

Advise EVERBRITE corporation of necessary replacement parts, or repairs.

Consignee will be invoiced and then should file a claim with the carrier to recover charges. To file your claim follow this procedure:

- (A) Cost of replacement parts or repair charges are invoiced to the carrier by the consignee.
- (B) The following documents, properly filled out, plus invoice, are forwarded to the trucking company in support of your claim:
 - (a) Original bill of lading
 - (b) Original paid freight bill
 - (c) Certified copy of original invoice
 - (d) Standard form for presentation of loss and damage claim

2. INSTALLATION

2.1 General Information

Shipping papers accompany each scoreboard. Check carefully to see that you receive the following:

- 2 ea Fouls Displays
- 1 ea Control Console
- 1 ea Service Manual
- 1 ea Mounting Hardware Package
- 1 ea Wall Junction Box
- ? ft Control Cable (if ordered)

IMPORTANT!

The MP-41 cable supplied by ALL AMERICAN SCOREBOARDS for use on the Microprocessor based scoreboards is specifically designed for this system. Use of a substitute cable may void the warranty on the scoreboard!

2.2 Inspection

Tighten all screws and fittings that may have loosened in shipment.

2.3 Pre-Test

Before installing the scoreboard, pre-test all functions.

- (A) Connect the scoreboard to a 20 AMP, 120 Volt AC circuit.



- (B) Plug the control console into the top of the displays.
- (C) Test operate all functions on the each display according to operating instructions in section 3 of this manual.
- (D) When all the functions test out, disconnect the power and the control console before hanging the fouls panels.

2.4 Data Cable Installation

The MP-41 data cable carries only low voltage signals and therefore can be installed with or without conduit. Consult section 6 for junction box and scoreboard wiring.

2.5 Electrical Connections

The fouls panel requires a 120 V. 20 AMP AC circuit for the exclusive use of the set.

NOTE

To protect the MP-2002 control from damage, it is advisable that you disconnect the control and store in a dry secure area when not in use.

NOTE

This equipment is not yet **ETL** (Electronics Testing Laboratories) approved, but complies with the requirements in part 15 of the FCC rules for a class A computing device. Operation of this equipment in a residential area may cause unacceptable interference to radio and television reception, requiring the operator to take whatever steps are necessary to correct the interference.

3. CONTROL CONSOLE OPERATION

3.1 Fouls Panel Display Power

Turn on the branch circuit to the displays. The displays will be blank.

3.2 Console Power

Plug the control console cable into the wall junction box.

Push **ON/OFF** once to turn the console on.

Push **ON/OFF** a second time to shut the console off. The console display should show **CODE** when first turned on.

Enter the two digit code (47) as in the following example:

Push **CODE** **4** **7** **ENTER**.

When the proper code has been entered, the console display will show “GO”

3.3 Console Display

The 4 digit Liquid Crystal Display module displays the information entered from the keyboard.

3.4 Player Numbers

To enter the player numbers for the corresponding foul positions enter the following:

PANEL Display will show “1”, indicating the first row. Proceed with the player number entries. If the players numbers were 12, 15, 28, etc. you would:

Push: **1** **2** **ENTER** . Display shows “2”.

Push: **1** **5** **ENTER** . Display shows “3”.

Push: **2** **8** **ENTER** . Display shows “4”.

Keep putting the players numbers in until you get to the 15th player. For the 15th row player number, after you put in the player number and push enter the display shows: “GO”.

Repeat the procedure for the guest foul panel.

To clear the entire panel turn the control console off.

3.5 Player Foul Entry

Once the player numbers have been entered it is very simple to enter the foul information.

Example: Player number 14 receives his/her first foul.

Push: **FOULS** **1** **4** **ENTER** **+1** **ENTER** .

3.6 Player In Game Entry/Substitution

An arrow indicates the players that are currently in the game. To turn an arrow on:

Push **SUB** followed by the players number, then **ENTER** .

To turn an arrow off: Push **SUB** followed by the players number, then **ENTER** .

The cancel button stops the current entry and clears the control for a new entry.

4. MAINTENANCE AND TROUBLESHOOTING

4.1 Introduction

This section gives maintenance and troubleshooting information. Included are troubleshooting guides for typical scoreboard malfunctions. If the cause of a problem cannot be determined, please contact the customer service department.

WARNING !!!

120 VAC wires are exposed whenever the cover over the power supply assembly is removed from the scoreboard. Use extreme caution during troubleshooting or repair. To avoid possible damage to equipment or personal injury, always turn off the main power before removing the cover or replacing assemblies, or replacing lamps.

4.2 Test Equipment

A simple analog or digital voltmeter will be sufficient for all user repairable problems. Printed circuit boards requiring troubleshooting should be returned to the factory.

4.3 Troubleshooting

Whenever possible, follow the troubleshooting guides prior to contacting the customer service department. If a problem not described in the guides exists, contact the customer service department immediately. Refer to the diagrams provided for assistance in troubleshooting scoreboard malfunctions.

4.4 Troubleshooting Guides

- (A) Scoreboard doesn't light and console doesn't work:
 - (a) Check that the main power switch is turned on.
 - (b) Replace any defective or blown fuses.
 - (c) Check the power connections and voltages at the scoreboard.
 - (d) Contact the customer service department.

- (B) Scoreboard digits don't light but the console works:
 - (a) With the main power switch "OFF"; remove the cover over the power supply and receiver.
 - (b) Check all connections.
 - (c) Turn the main power on.
 - (d) If the scoreboard still doesn't light, check the transformer voltage going to the receiver PCB (printed circuit board) assembly (blue wires) using a voltmeter set on the 12 VAC or higher scale.

If the voltage is less than 8 VAC contact the customer service department.

If the voltage is between 8-12 VAC see the replacement parts list for a receiver PCB assembly, and contact the customer service department.

(C) The scoreboard digits light but the console doesn't work:

- (a) Check for continuity between the scoreboard and the junction box.
- (b) If an open circuit is found, the problem is either the cable or a cable connection.
- (c) If the continuity test checks good, check the voltage between the green wire and the white wire in the junction box, using a voltmeter set on the 12 VAC or higher scale.

If the voltage is 0 VAC see the controller parts list for a transformer assembly.

If the voltage is less than 8 VAC consult the controller wiring diagram for instructions on long cable compensation.

If the voltage is between 8 VAC and 12 VAC contact the customer service department.

(D) The scoreboard digits light the console works, but there is no control of the scoreboard:

- (a) Check the voltage between the black and red wires in the junction box with a voltmeter set on the 3 VDC or higher scale. The voltage should read somewhere between 2-3 VDC when the console is working properly.
- (b) If the voltage is 0 VDC contact the customer service department for assistance.
- (c) If the voltage is correct, (2-3 VDC) check that this reading also appears at the scoreboard.
- (d) If the correct voltage also appears at the scoreboard, see the replacement parts list for a receiver PCB assembly.

(E) The scoreboard works, but some lights stay on all the time

- (a) With the main power "OFF", switch the plug from the bad digit with the plug for a known good digit. EXAMPLE: Plug "C" into "D" and "D" into "C" locations.
- (b) Turn the power back on. If the same lamps remain lit all the time, the problem is a shorted lamp socket. If the lamps on a different digit now stay lit all the time, the problem is on the driver PCB assembly. See the replacement parts list for the proper replacement part.

(F) The scoreboard works, but some lights do not come on.

- (a) Check for burned out lamps.
- (b) Check for a broken wire or bad connection on the 12 pin connector.
- (c) See the replacement parts list for the proper replacement driver board.

CLUSTER REMOVAL

If it becomes necessary to remove a LED cluster: Insert a pointed object, like the end of a ball point pen, into the two holes in the cluster retaining ring, and rotate the cluster until these holes are at 3:00 o'clock and 9:00 o'clock. At this position the cluster should be removable from the front of the face of the scoreboard. Reverse the procedure to install the cluster.

5. REPLACEMENT PARTS

5.1 Scoreboard Display Parts

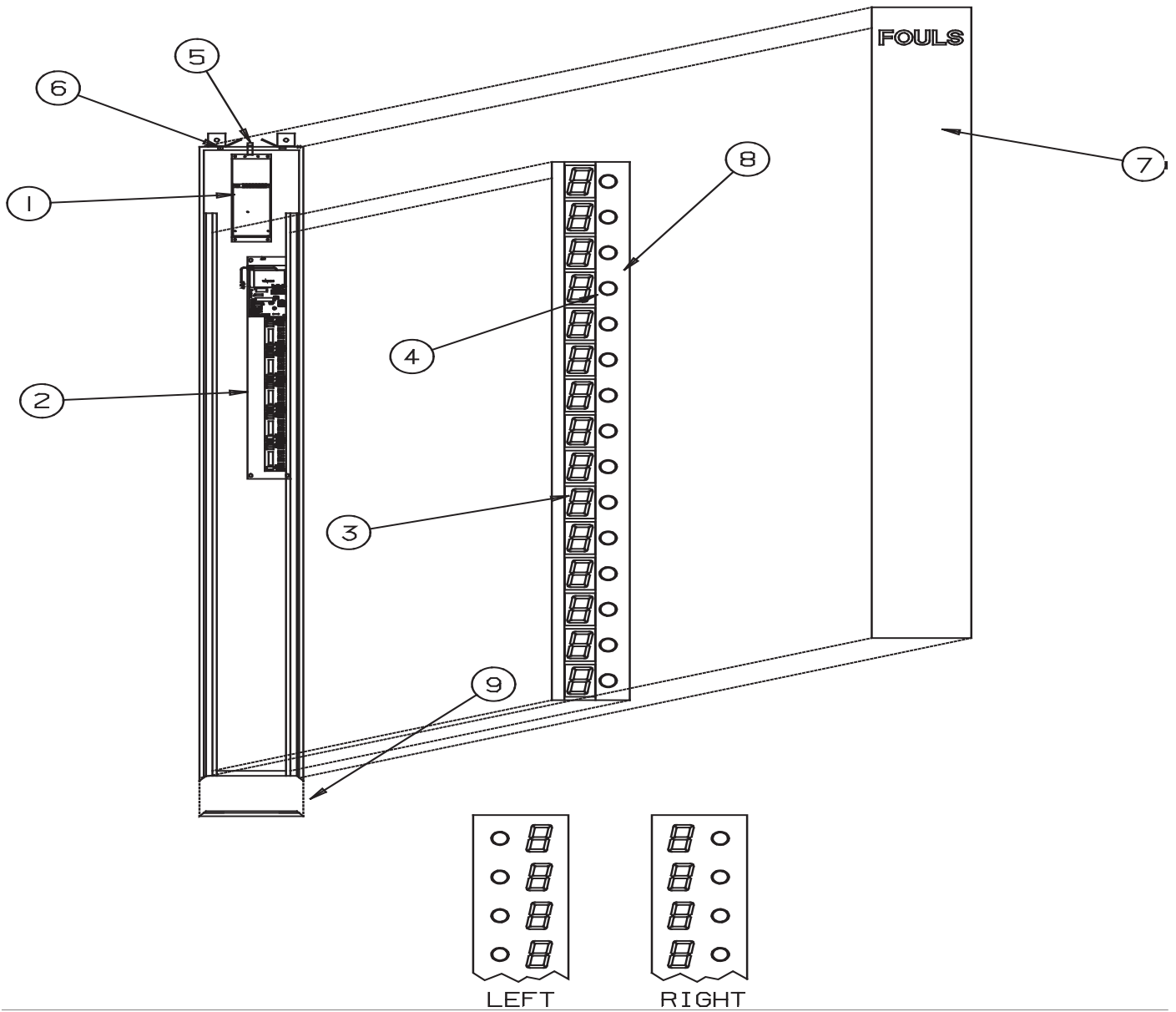

figure 1

DISPLAY ASSEMBLY

REPLACEMENT PARTS LIST (MP-5215)

fig.& index	MFG PART NUMBER	DESCRIPTION	REF DES	VENDOR PART #
1-	153006	Display Assembly		153006
1-1	151283	Face, Red Plex.		151283
1-2	150366	Receiver PCB Assembly *** PROGRAM ***	A2	150366
1-3	151485	Driver Assy, 3 Digit Display	A3-A6	151485
1-4	703719	Transformer, MP 12V/18V	T1	C-1106
1-5	350050	Transformer, 12V/8A	T2	C-1082
1-6	705075	Ribbon Cable Assy, W/2 Fem.Connectors		AS-1053
1-7	701137	Terminal Block, 7C	TB-1	670-7
1-8	701036	Fuseholder		342001A
1-9	701049	Fuse, 3A 250V 1/4 X 1 1/4	F1	MDX-3 Slo Blo
1-10	702786	Connector, 5 Pin Female	J1	RM12BRD5S
1-11	120387 119771 150184 702785 EL057700 151682 WH009100 122763	Control Console Slipsheet Transmitter PCB Assembly Connector, 5 Pin Male Cable LCD Display, 2 Line 20 Character Keyboard Assembly, Ribbon Cable Assembly, 14C 8" Enclosure,	A1 P1	120387 119771 150184 RM12BPG5P 151682 WH009100
1-12	150204 930895 150500	Wall Junction Box, Single Connector, 5 Pin Female Cable, MP-41 Control	J1	150204 RM12BRD5S 8723
1-13	118513 930895 150500	Splitter Junction Box Connector, 5 Pin Male CCT Cable, MP-41 Control	P1/P2	118513 RM12BPG5P 8723

6. DIAGRAMS

6.1 Control Console Keyboard and Slipsheet Layout

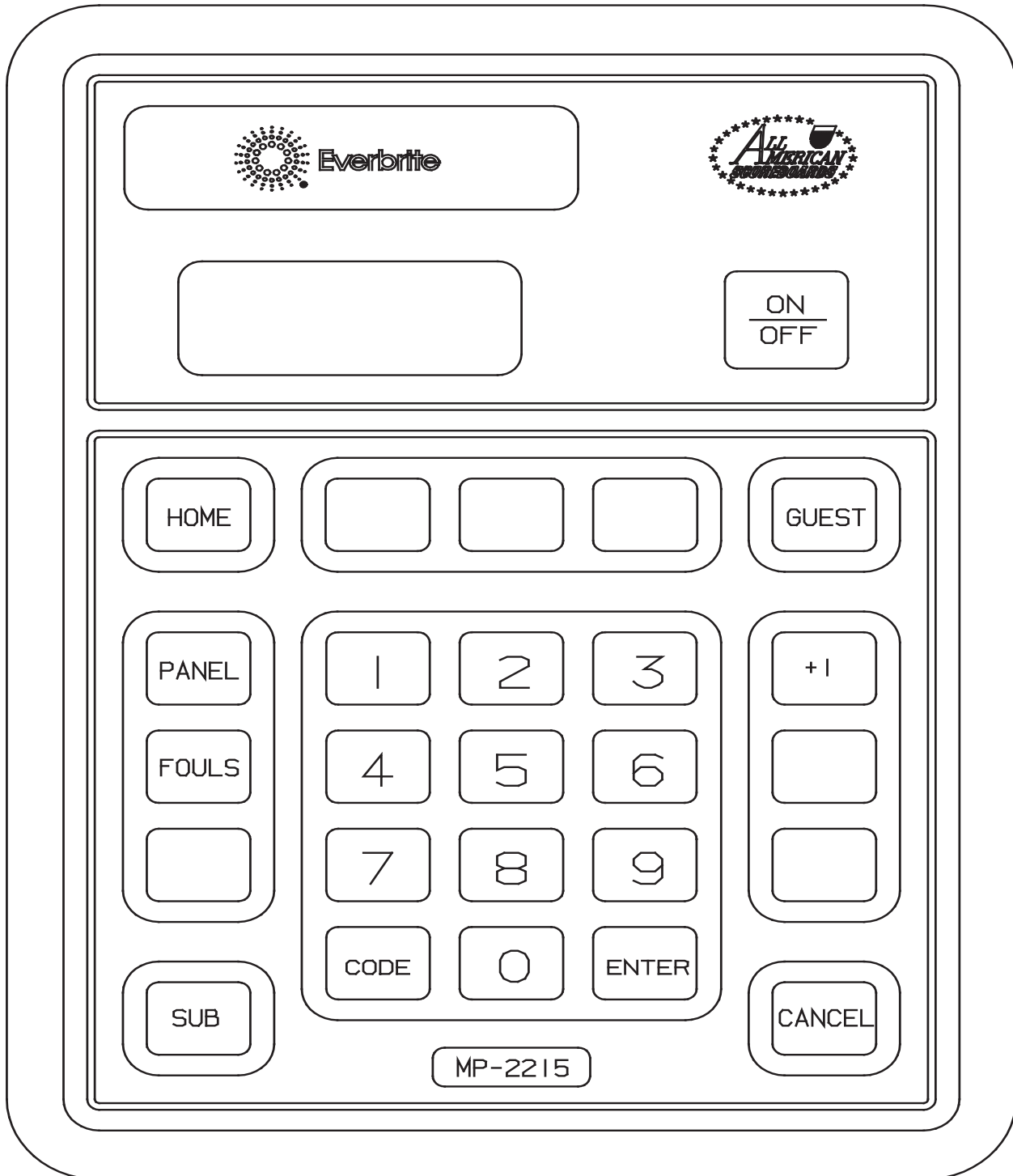

CONSOLE KEYBOARD

6.2 Scoreboard System Layout

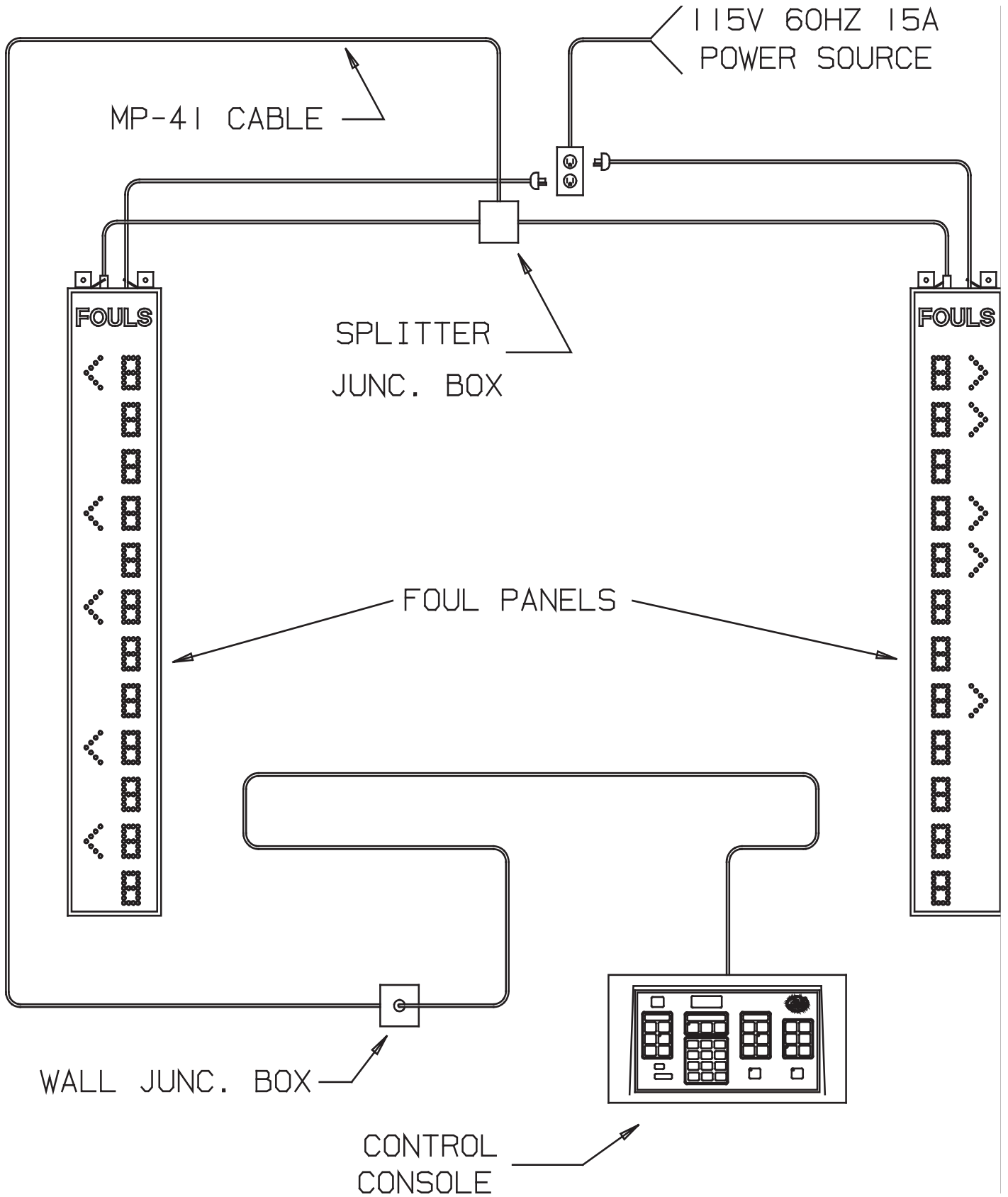

SYSTEM LAYOUT

6.3 Junction Box Wiring

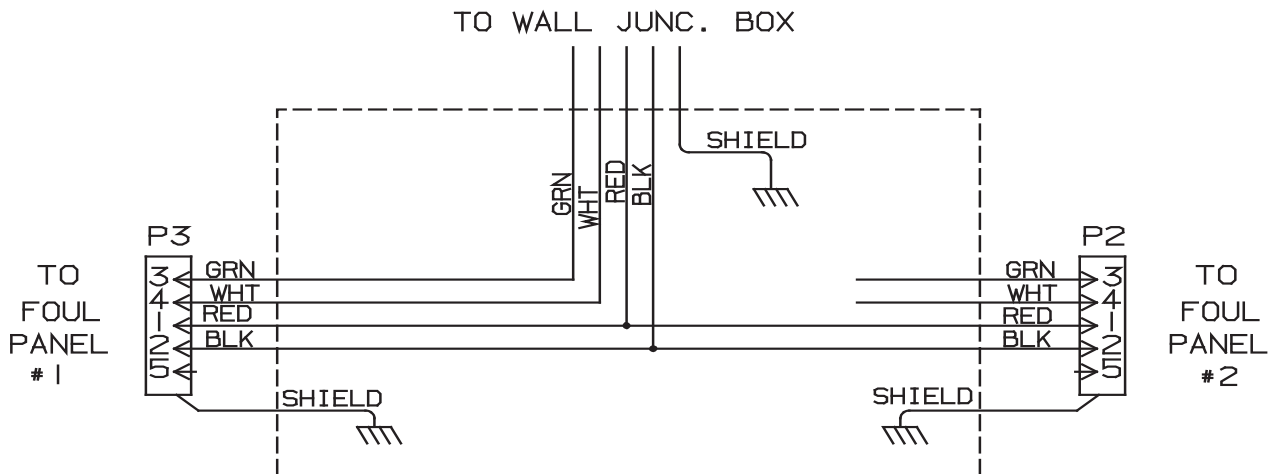
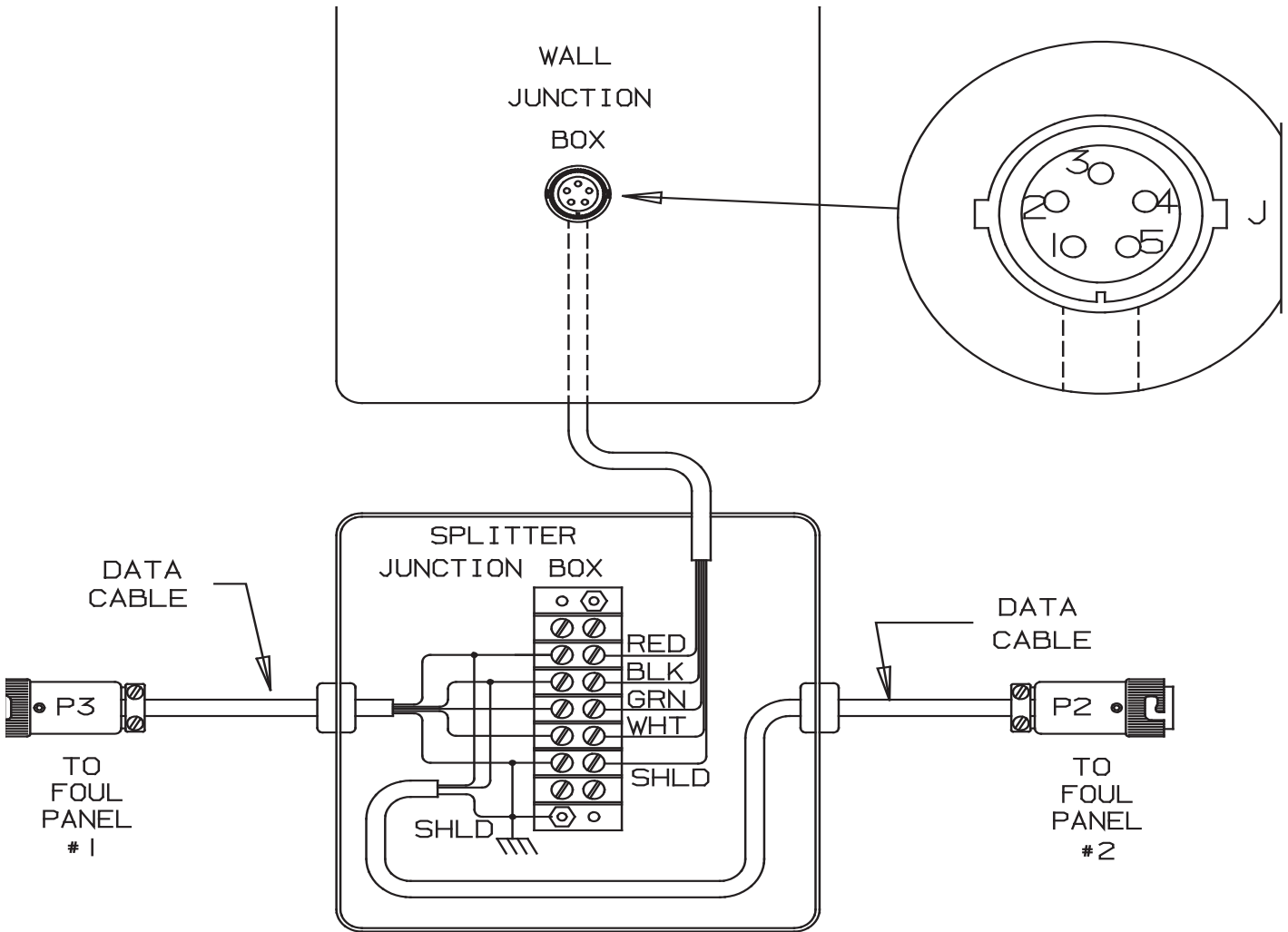

JUNCTION BOX WIRING

6.4 Fouls Panel Wiring

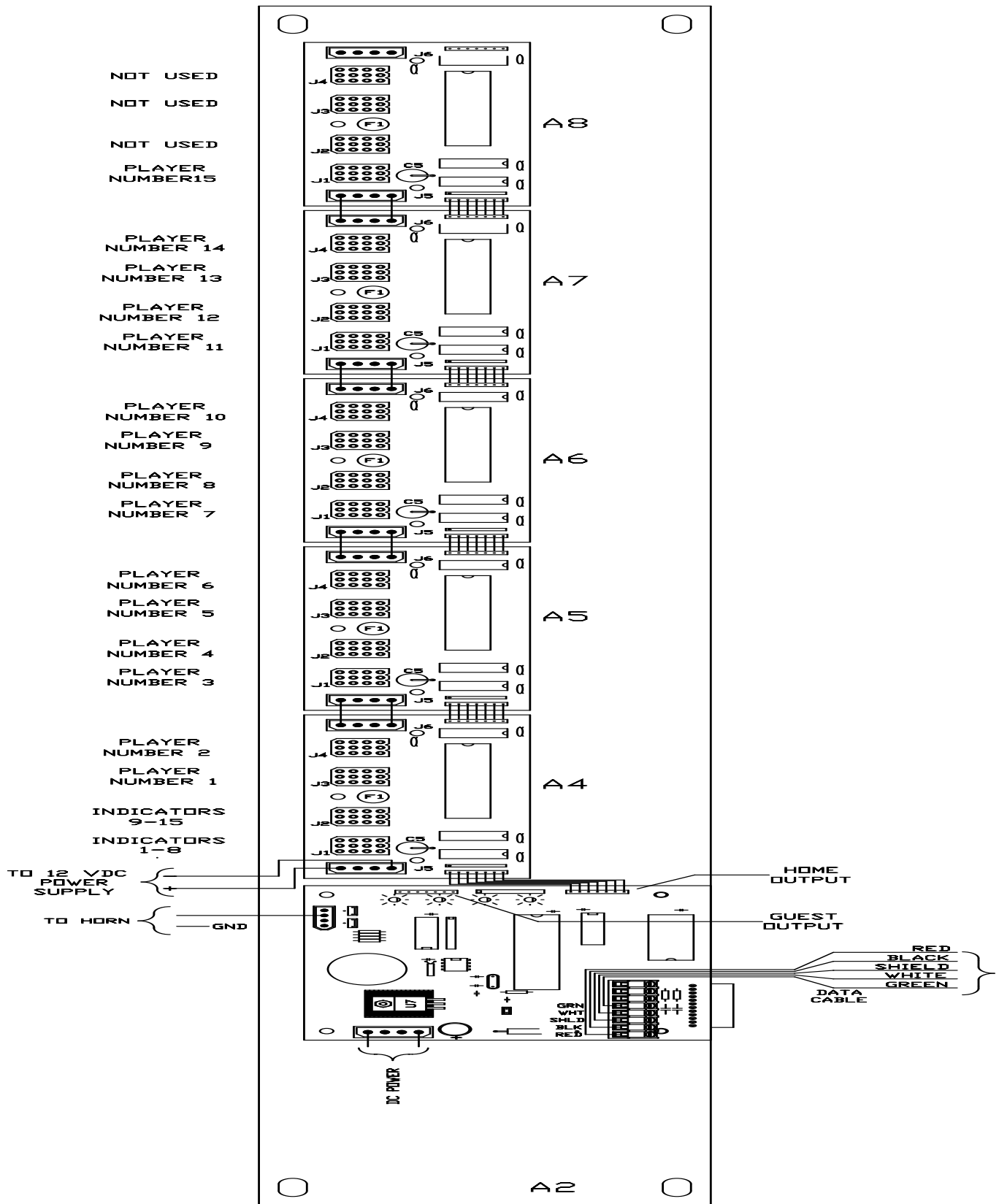

FOULS PANEL WIRING

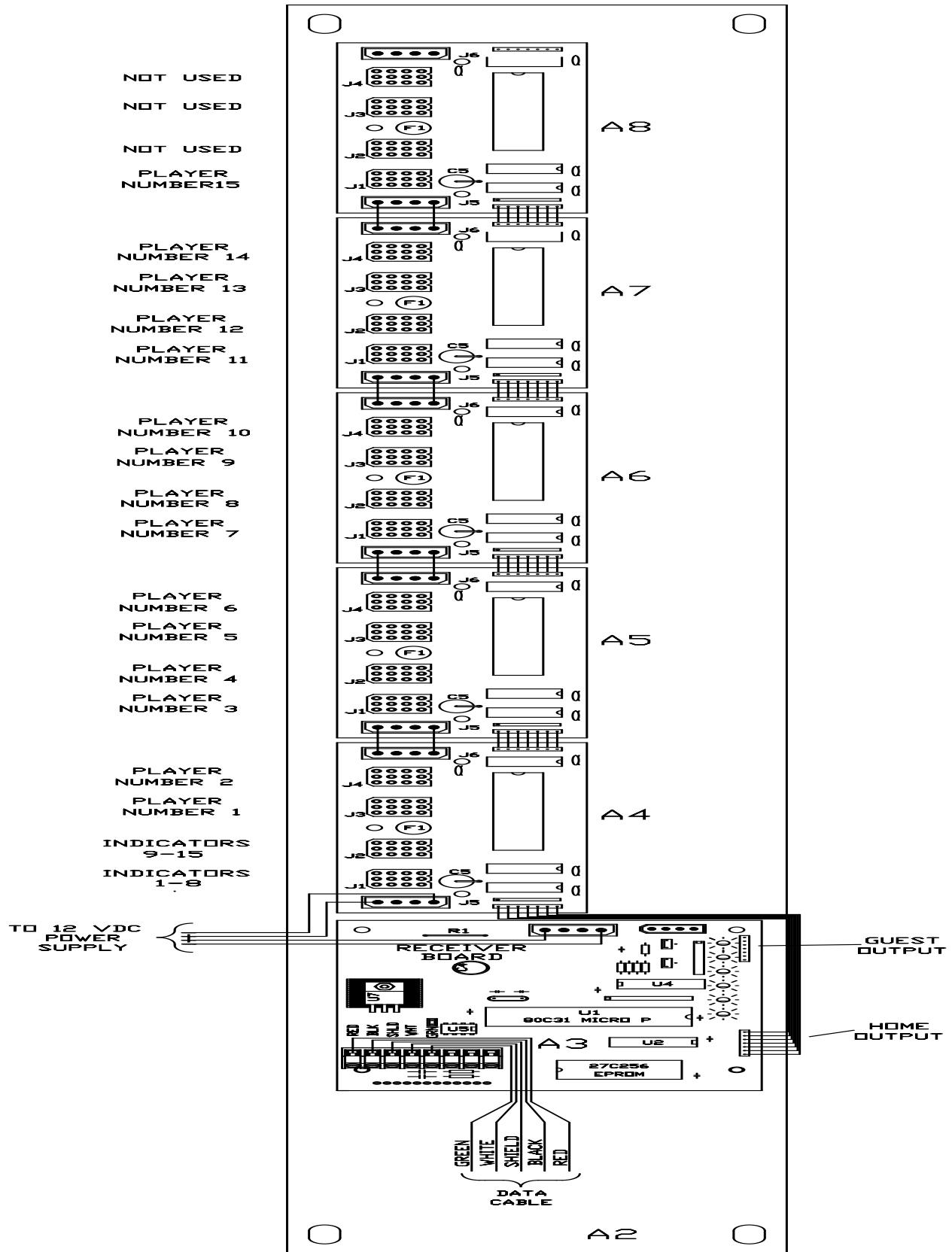

FOULS PANEL WIRING

6.5 Installation Drawing

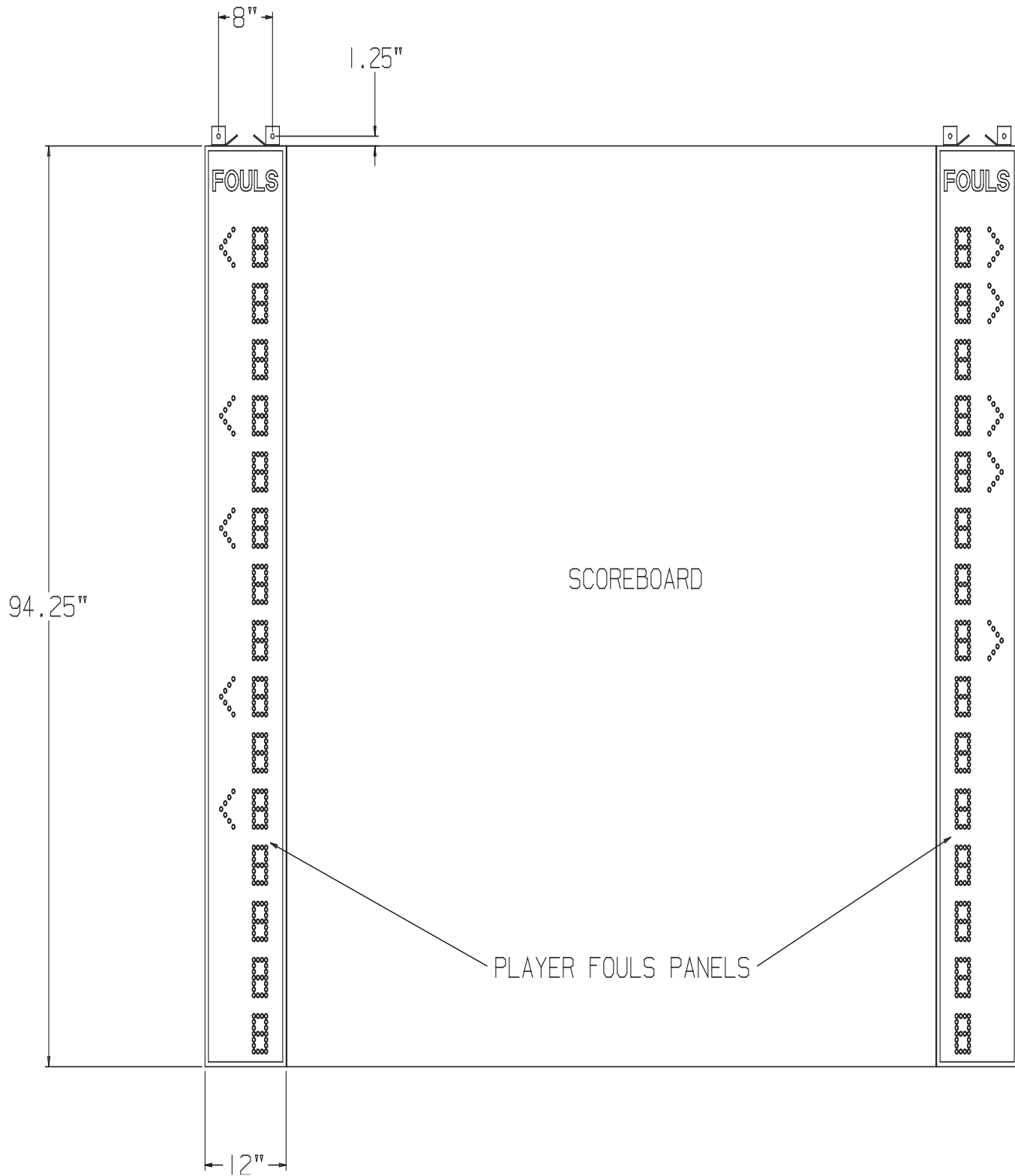

INSTALLATION DRAWING