



OPERATING INSTRUCTIONS AND SERVICE MANUAL

OUTDOOR VOLLEYBALL SCOREBOARD

MODEL MP-3610

HOME	GUEST	
	SERVING	

# TABLE OF CONTENTS

## 1. General Information

- 1.1 Description
- 1.2 Identification
- 1.3 Damage
- 1.4 Damage Claim Procedure

## 2. Installation

- 2.1 General Information
- 2.2 Inspection
- 2.3 Mounting
- 2.4 Data Cable Installation
- 2.5 Electrical Connection

## 3. Control Console Operation

- 3.1 Scoreboard Power
- 3.2 Control Console Display
- 3.3 Control Console Power
- 3.4 Team Scores
- 3.5 Serving
- 3.6 Dimmer

## 4. Maintenance and Troubleshooting

- 4.1 Introduction
- 4.2 Test Equipment
- 4.3 Troubleshooting
- 4.4 Troubleshooting Guide

## 5. Replacement Parts List

- 5.1 Scoreboard Display Parts
- 5.2 Controller Assembly

## 6. Diagrams

- 6.1 Control Console Keyboard Layout (Slipsheet)
- 6.2 Scoreboard Layout
- 6.3 Junction Box Wiring
- 6.4 Power Wiring
- 6.5 Controller Assembly Wiring and Layout
- 6.6 Microprocessor 4 x 7 Lamp Pattern (8 Bit) (A-12497)
- 6.7 Figuregram Wiring Diagram
- 6.8 Jumper Location on 3 Position Driver Board
- 6.9 Triac Placement Diagram
- 6.10 Installation Drawings

## 1. GENERAL INFORMATION

### 1.1 DESCRIPTION

Your All-American scoreboard has been carefully inspected and tested before leaving the factory. It is possible, however, that components may be loosened or forced out of adjustment in transit. If this occurs, follow the troubleshooting guide (section 4). If equipment then fails to operate, contact immediately:

**ALL-AMERICAN Service Department  
EVERBRITE LLC  
P.O. Box 100  
Pardeeville, WI 53954  
Telephone: (608) 429-2121  
Toll Free: 800-356-8146  
E-mail: [score@everbrite.com](mailto:score@everbrite.com)**

Parts being returned for repair are to be sent to:

**ALL-AMERICAN Service Department  
EVERBRITE LLC  
401 S. Main Street  
Pardeeville, WI 53954**

#### NOTE

If you need to send parts in for repair, please call the ALL AMERICAN service department for a returned goods authorization (RGA) number.

### 1.2 Identification

ALL-AMERICAN uses a 4 or 5 digit serial number for scoreboard identification. The serial number tags are located on the back of the control console and the lower right hand corner on the face of the scoreboard display. When contacting the factory for assistance it is important that the model number and serial numbers are known.

### 1.3 Damage

Upon receipt, check for visible damage. If this occurs, or if damage is found after shipment has been accepted, follow the damage claim procedure.

### 1.4 Damage Claim Procedure

An instruction sheet is enclosed advising the consignee in case of damage in transit.

If damage is noted at the time of delivery, consignee must obtain an 'Inspection of Bad Order' from the delivering carrier. In order to process your claim, this must be properly filled out

with a complete statement of all damage and it must be signed by the carrier.

If damage is discovered after delivery, you should call the delivery company. Have them make out a Concealed Damage Report. Fifteen days after delivery are allowed, so this should be done promptly or it is impossible to process this claim.

Advise EVERBRITE corporation of necessary replacement parts, or repairs. Consignee will be invoiced and then should file a claim with the carrier to recover charges. To file your claim follow this procedure:

(A) Cost of replacement parts or repair charges are invoiced to the carrier by the consignee.

(B) The following documents, properly filled out, plus invoice, are forwarded to the trucking company in support of your claim:

- (a) Original bill of lading
- (b) Original paid freight bill
- (c) Certified copy of original invoice
- (d) Standard form for presentation of loss and damage claim

## 2. INSTALLATION

### 2.1 General Information

Shipping papers accompany each scoreboard. Check carefully to see that you receive the following:

- 1 ea Volleyball Display
- 1 ea Control Console
- 1 ea Service Manual
- 1 ea Mounting Hardware Package
- 1 ea Press Box Junction Box
- ? ft Control Cable (if ordered)

**IMPORTANT!**

The MP-40 cable supplied by ALL AMERICAN SCOREBOARDS for use on the Microprocessor based scoreboards is specifically designed for this system. Use of a substitute cable may void the warranty on the scoreboard!

### 2.2 Inspection

Inspect each unit and tighten all screws, lamps, and fittings that may have loosened in shipment.

## 2.3 Installation

Select the location best suited for visibility by the majority of spectators. Preferred position is facing east or north to avoid direct sunlight on the face of the scoreboard, if day games are played.

The MP-40 data cable carries only low voltage signals and therefore can be installed with or without conduit. Consult section 6 for junction box and scoreboard wiring.

## 2.4 Electrical connections

This scoreboard requires one 120 V. 15 A. AC circuit for the exclusive use of the scoreboard.

### IMPORTANT !!!

To protect the MP-2002 control from damage, it is advisable to disconnect the control and store in a dry secure area when not in use.

### NOTE

This equipment is **ETL** (Electronics Testing Laboratories) **CSA** and **NRTL** approved and complies with the requirements in part 15 of the FCC rules for a class A computing device. Operation of this equipment in a residential area may cause unacceptable interference to radio and television reception, requiring the operator to take whatever steps are necessary to correct the interference.

## 3. CONTROL CONSOLE OPERATION

### 3.1 Scoreboard Power

Turn on the branch circuit to the scoreboard. The Home and Guest scores will show "0".

### 3.2 Console Display

The Liquid Crystal Display module displays the scoreboard information entered from the control console.

### 3.3 Console Power

Plug the control console cable into the Press Box junction box.

Push **ON/OFF** once to turn the console on.

Push **ON/OFF** a second time to shut the console off.

When first turned on; the console display should show **CODE**.

### 3.4 Initializing Scoreboard

Enter the four digit code (**3610**) shown in the lower center of the keyboard as in the following example:

Push **CODE** **3** **6** **1** **0** **ENTER** .

When the proper code has been entered, the console display will show **0000**.

### 3.5 Team Scores

The Home and Guest Scores can be changed in three different ways.

- (A) To add 1 to the existing score: Push **+1** .
- (B) To directly enter or correct a score: Push Home or Guest **SCORE** followed by the desired number, then **ENTER** .

Example: Present Home Score is 15. Change the score from 15 to 19.

Push: Home **SCORE** **1** **9** **ENTER** .

- (C) To clear the score: Push **SCORE** **0** .

### 3.6 Serving

Push **SERVE** once to increment the appropriate indicator.

### 3.7 Dimmer

Push **DIMMER** to dim the lamps during night use.

## WARNING

120 VAC wires are exposed whenever the cover over the controller assembly is removed from the scoreboard. Use extreme caution during troubleshooting or repair. To avoid possible damage to equipment or personal injury, always turn off the main power before removing the cover or replacing assemblies, or replacing lamps.

## 4. MAINTENANCE AND TROUBLESHOOTING

### 4.1 Introduction

This section gives maintenance and troubleshooting information. Included are troubleshooting guides for typical scoreboard malfunctions. If the cause of a problem cannot be determined, please contact the Customer Service Department.

### 4.2 Test Equipment

A simple analog or digital voltmeter will be sufficient for all user repairable problems. Printed circuit boards requiring troubleshooting should be returned to the factory.

### 4.3 Troubleshooting

Whenever possible, follow the troubleshooting guides prior to contacting the Customer Service Department. If a problem not described in the guides exists, contact the customer service department immediately. Refer to the diagrams provided for assistance in troubleshooting scoreboard malfunctions.

### 4.4 Troubleshooting Guides

#### (A) Scoreboard doesn't light and console doesn't work

- (a) Check that the main power switch is turned on.
- (b) Replace any defective or blown fuses.
- (c) Check the power connections and voltages at the scoreboard.
- (d) Contact the Customer Service Department.

#### (B) Scoreboard digits don't light, but the console works

- (a) With the main power switch "off"; remove the cover over the controller assembly.
- (b) Check all connections.
- (c) Turn the main power "on".
- (d) If the scoreboard still doesn't light, check the transformer voltage going to the receiver PCB (printed circuit board) assembly (blue wires) using a voltmeter set on the 12 VAC or higher scale.

If the voltage is less than 8 VAC contact the Customer Service Department.

If the voltage is between 8-12 VAC see the replacement parts list for a receiver PCB assembly, and contact the Customer Service Department.

#### (C) The scoreboard digits light but the console doesn't work

- (a) Check for continuity between the scoreboard and the junction box.
- (b) If an open circuit is found, the problem is either the cable or a cable connection.
- (c) If the continuity test checks good, check the voltage between the green wire and the white wire in the junction box, using a voltmeter set on the 12 VAC or higher scale.

If the voltage is 0 VAC see the controller parts list for a transformer assembly.

If the voltage is less than 8 VAC consult the controller wiring diagram for instructions on long cable compensation.

If the voltage is between 8 VAC and 12 VAC contact the Customer Service Department.

- (D) The scoreboard digits light, the console works, but there is no control of the scoreboard.
- (a) Check the voltage between the black and red wires in the junction box with a voltmeter set on the 3 VDC or higher scale. The voltage should read somewhere between 2-3 VDC when the console is working properly.
  - (b) If the voltage is 0 VDC contact the Customer Service Department for assistance.
  - (c) If the voltage is correct, (2-3 VDC) check that this reading also appears at the scoreboard.
  - (d) If the correct voltage also appears at the scoreboard, see the replacement parts list for a receiver PCB assembly.

- (E) The scoreboard works, but some lights stay on all the time

- (a) With the main power "OFF", switch the plug from the bad digit with the plug for a known good digit.

EXAMPLE: Plug "C" into "D" and "D" into "C" locations.

- (b) Turn the power back on. If the same lamps remain lit all the time, the problem is a shorted lamp socket. If the lamps on a different digit now stay lit all the time, the problem is on the driver PCB assembly. See the replacement parts list for the proper replacement part.

### **IMPORTANT !!!**

In this scoreboard the 120 volt line is on the lamp socket all the time, and the common is switched to turn the lamps on and off. For this reason, to avoid damage to the equipment or personal injury, it is important to turn the main power off when changing the lamps.

- (F) The scoreboard works, but some lights do not come on.
- (a) Check for burned out lamps.
  - (b) Check for a broken wire or bad connection on the 12 pin connector.
  - (c) See the replacement parts list for the proper replacement driver board.



## 5. REPLACEMENT PARTS LIST

### 5.1 Scoreboard Display Parts

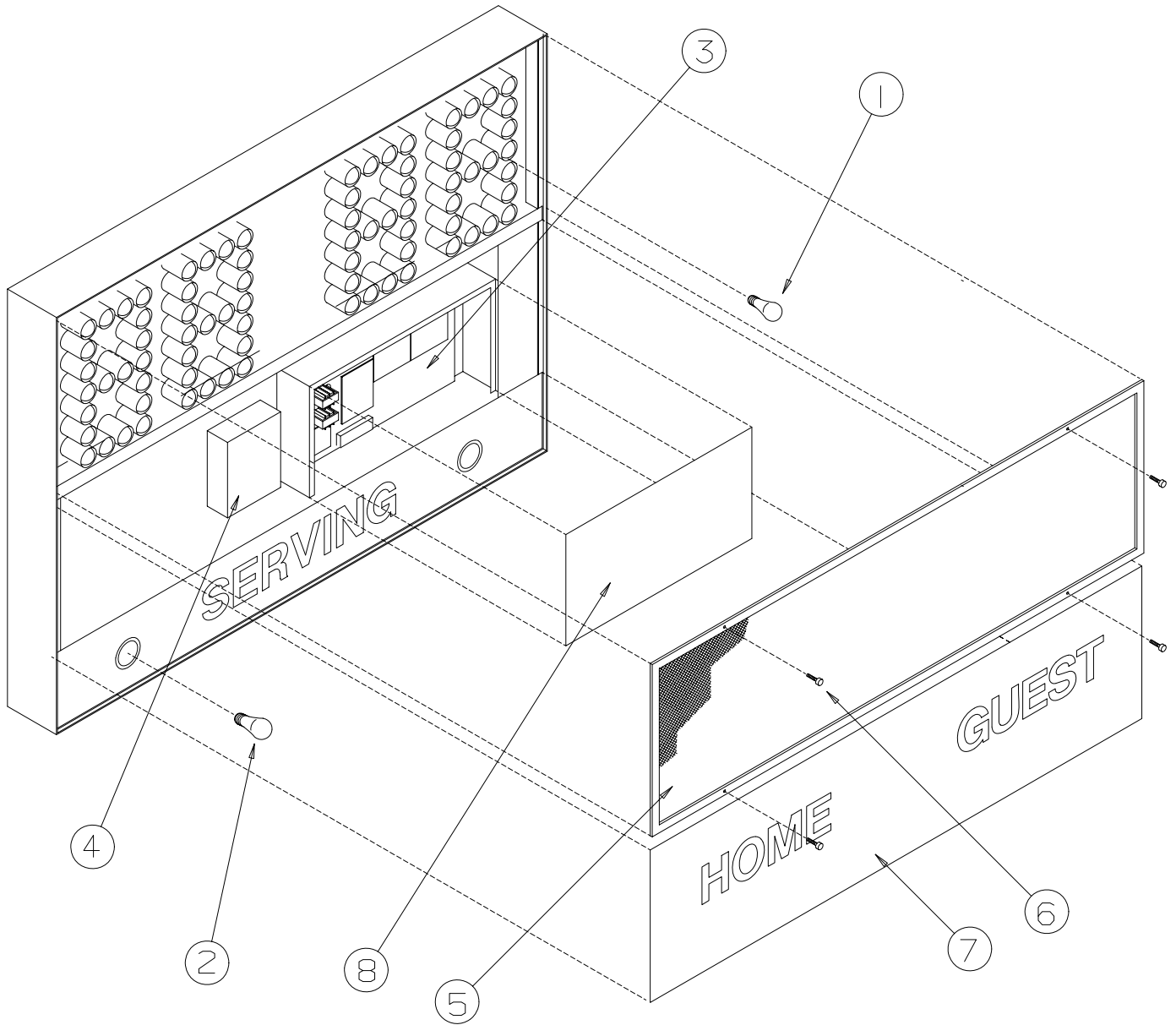

figure 1

DISPLAY ASSEMBLY

## REPLACEMENT PARTS LIST (MP-3610)

fig. & index	MFG PART NUMBER	DESCRIPTION	REF DES	VENDOR PART #
1-	000000	Display, MP-3610		000000
1-1	850022	Lamp, 15W/130V Clear (Scores)		15A15CL
1-2	850030	Lamp, 25W/130V Clear (Serving)		25A19 GR CL
1-3	SU479000	Controller Assembly, W/2-3P Drivers *****SEE DETAIL FIGURE 2*****	A2	SU479000
1-4	SU00038	Fuse Box Assy,		SU00038
1-4A	121880	Fuse, 15A 250V	F1-F2	ABC-15
1-5	120386	Screen,		120386
1-6	903370	Thumbscrew, 10-24 X 1"		903370
1-7	159090	Service Door		159090
1-8	EL00079	Rain Shield Cover		EL00079
1-9	705606	Lamp Socket		
1-10	705803	Reflector Cup, 2 1/4"		
1-11	705802	Reflector Cup, 3"		
1-12	EL044100	Resistor, 2 OHM 30 WATT Wire Wound		HL-24-09Z
	120387	Control Console ***** PROGRAM MP2CSLV44 *****		120387
	119771	Slipsheet Pair		119771
	150184	Transmitter PCB Assembly	A1	150184
	702785	Connector, 5 Pin Male Cable	P1	RM12BPG5P
	151002	Press Box Junction Box,		151002
	702786	Connector, 5 Pin Female	J1	RM12BRD5S
	150508	Cable, MP-40 Control		YR21233

## 5.2 Scoreboard Controller Assembly Parts

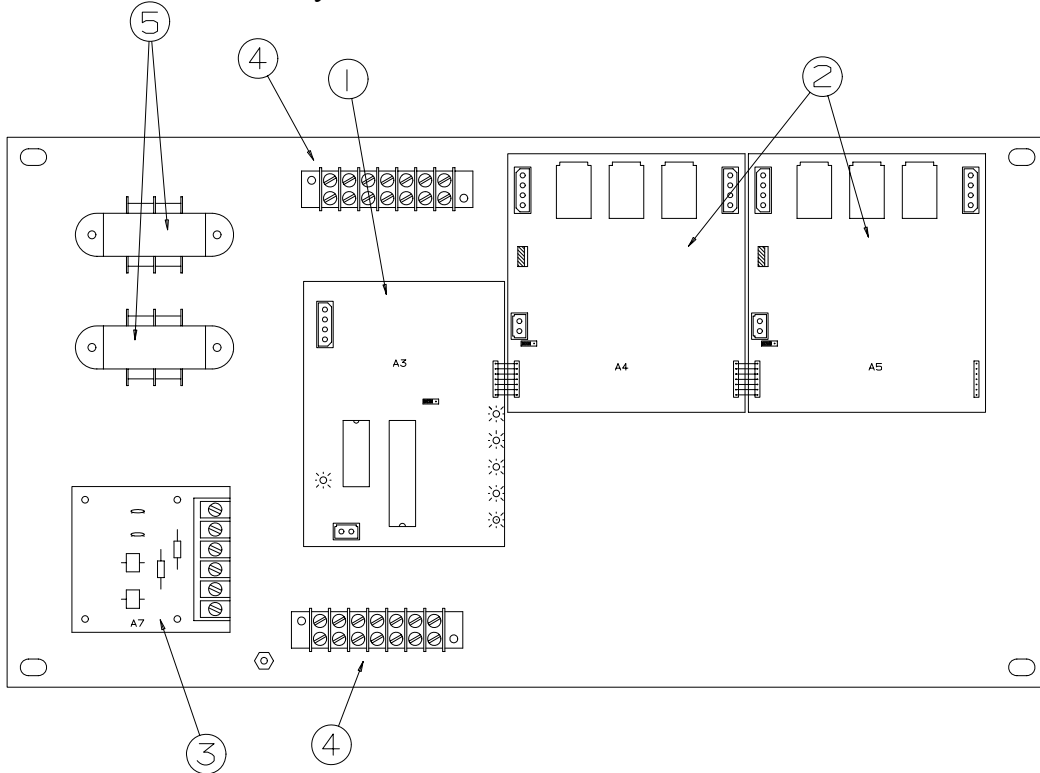

figure 2

### CONTROLLER ASSEMBLY

REPLACEMENT PARTS LIST (MP-3610) Controller Assembly				
fig.& index	MFG PART NUMBER	DESCRIPTION	REF DES	VENDOR PART #
2-	SU479000	Controller Assembly	A2	SU479000
2-1	119323	Receiver PCB Assembly *** PROGRAM 3MP-CNT-V16***	A3	119323
2-2	118922	Driver PCB Assembly, 3 Position	A4-A5	118922
2-3	118522	Transient Suppressor PCB Assembly	A8	118522
2-4	701137	Terminal Block, 7C	TB1&2	670-7
2-5	703719	Transformer, 8V/18V	T1/T2	CS-697
2-6	HB005600	Cover		HB005600
2-7	705723	Spacer, P.C. Board		LCBS-6-01

6. DIAGRAMS

6.1 Control Console Keyboard and Slipsheet Layout

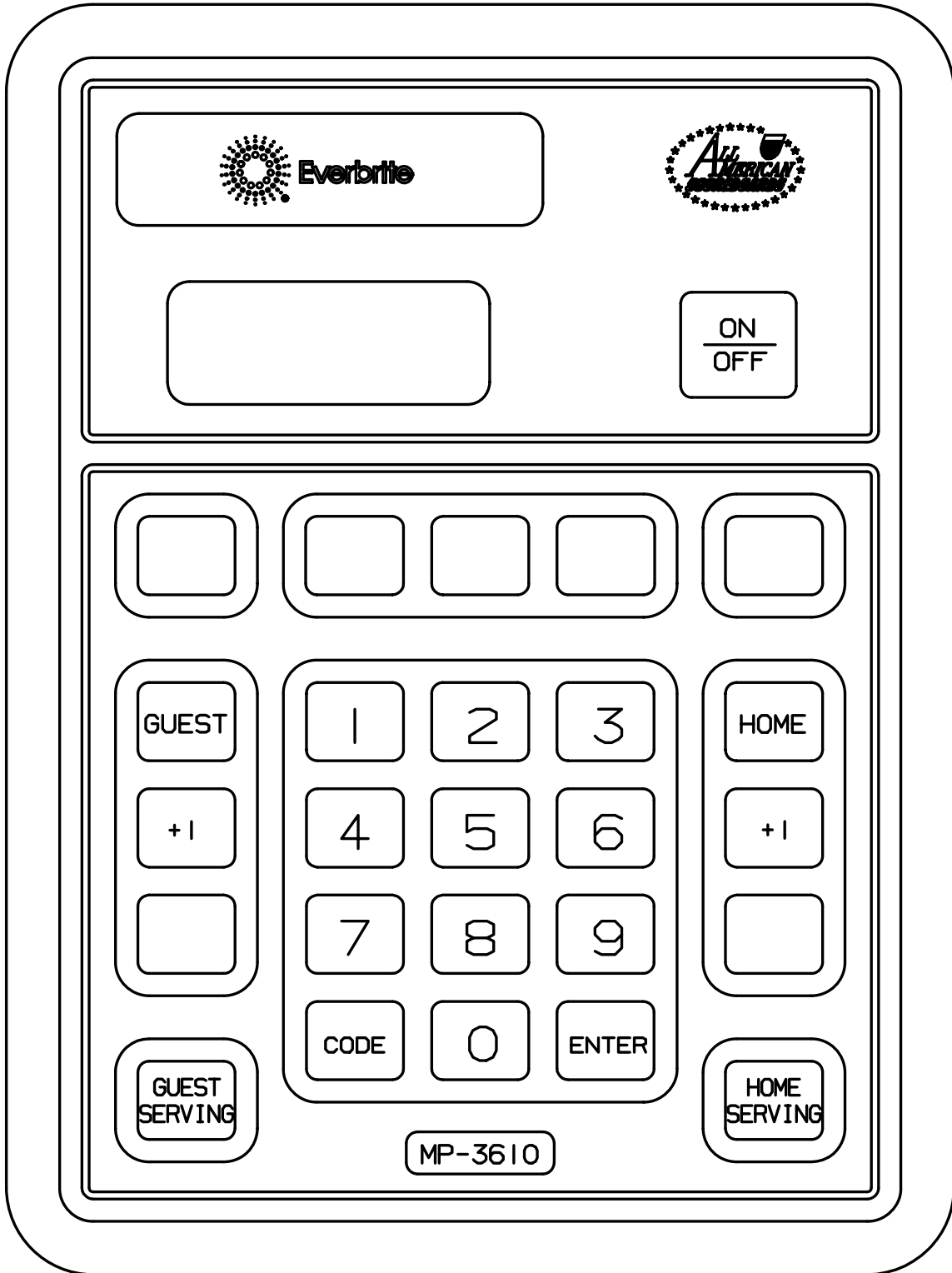

figure 3

# CONSOLE KEYBOARD

## 6.2 Scoreboard System Layout

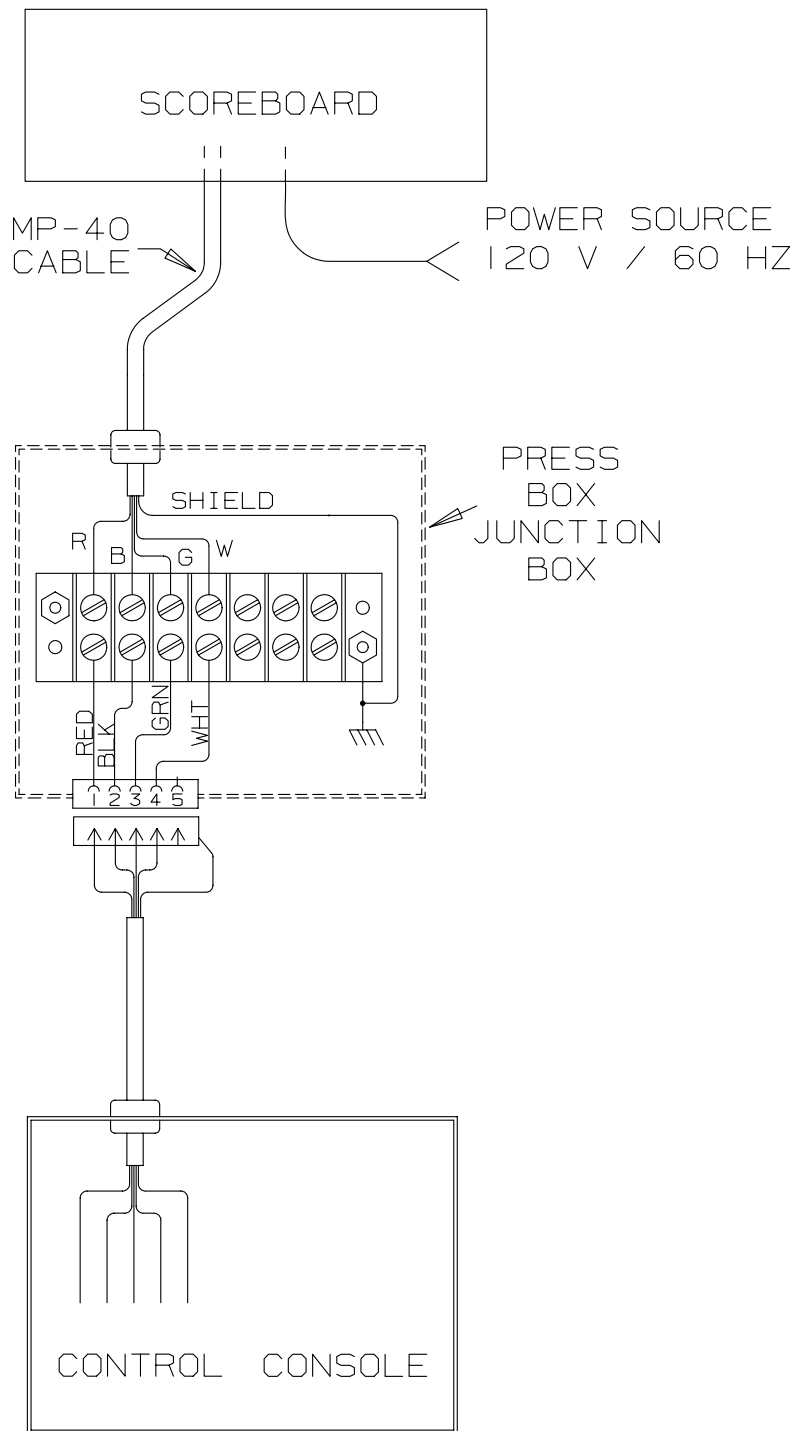
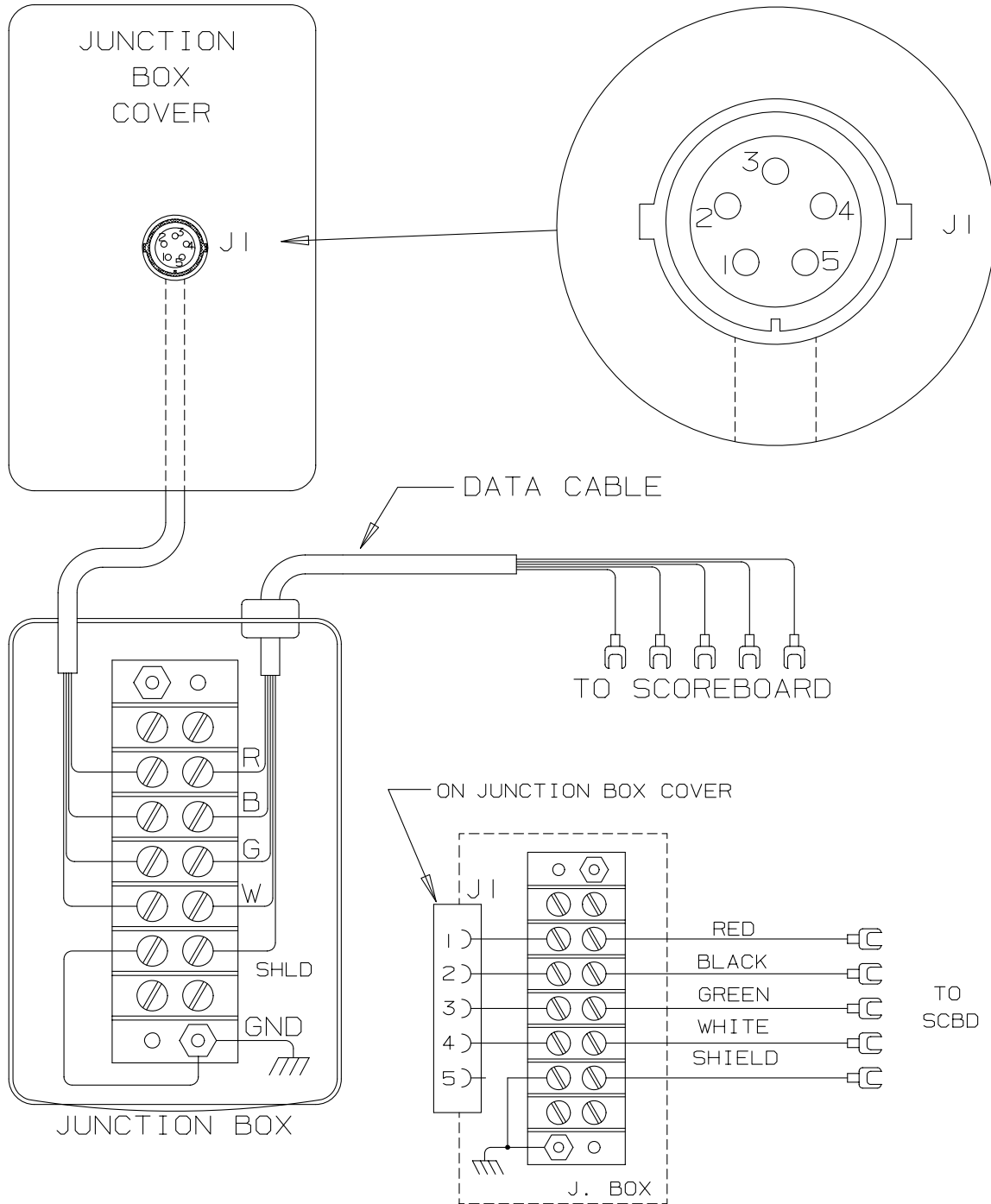

figure 4

# SYSTEM LAYOUT

## 6.3 Single Junction Box Wiring



SINGLE JUNCTION BOX WIRING

6.4 Power Wiring

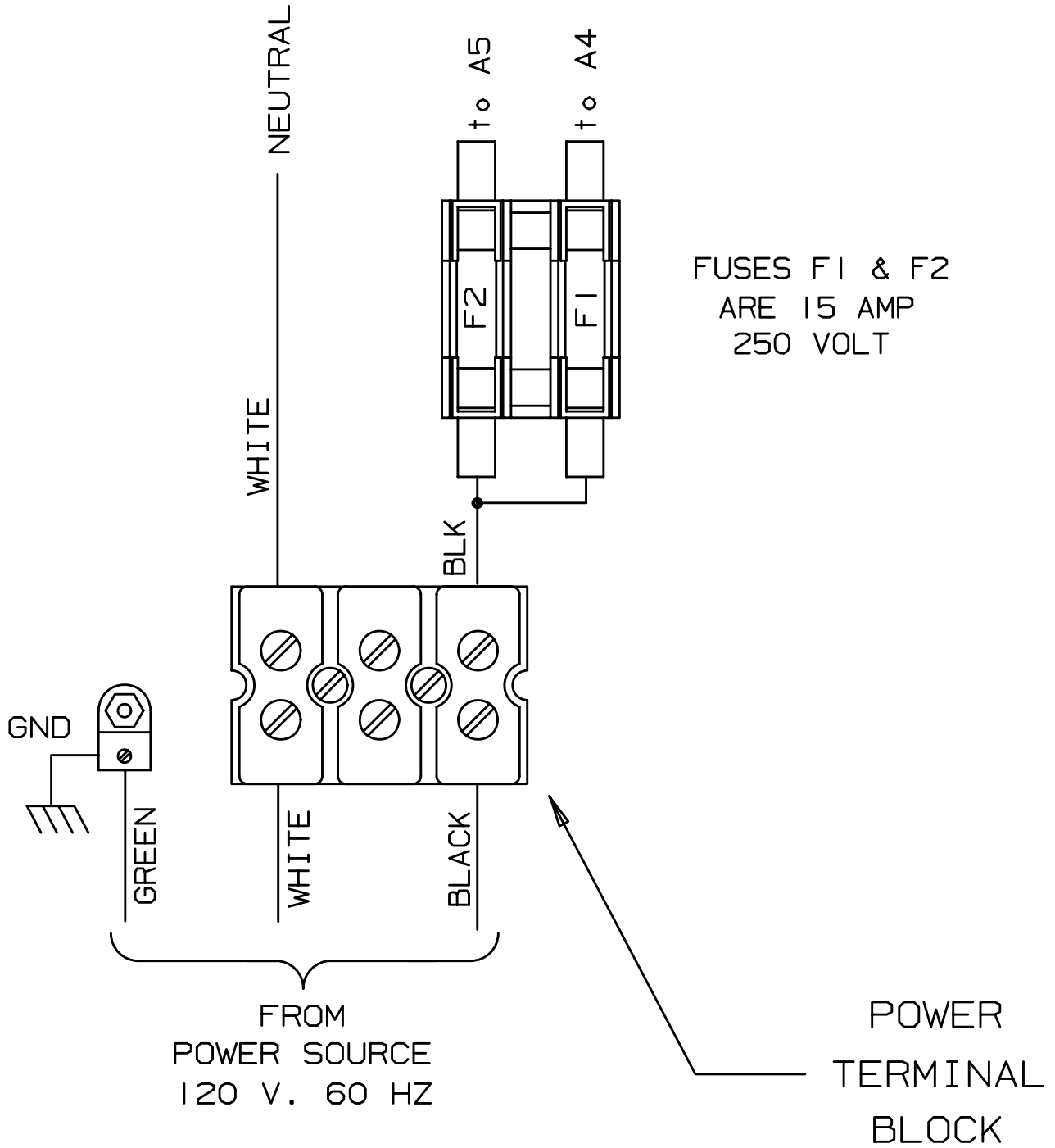

## POWER WIRING

### 6.5 Controller Assembly Wiring



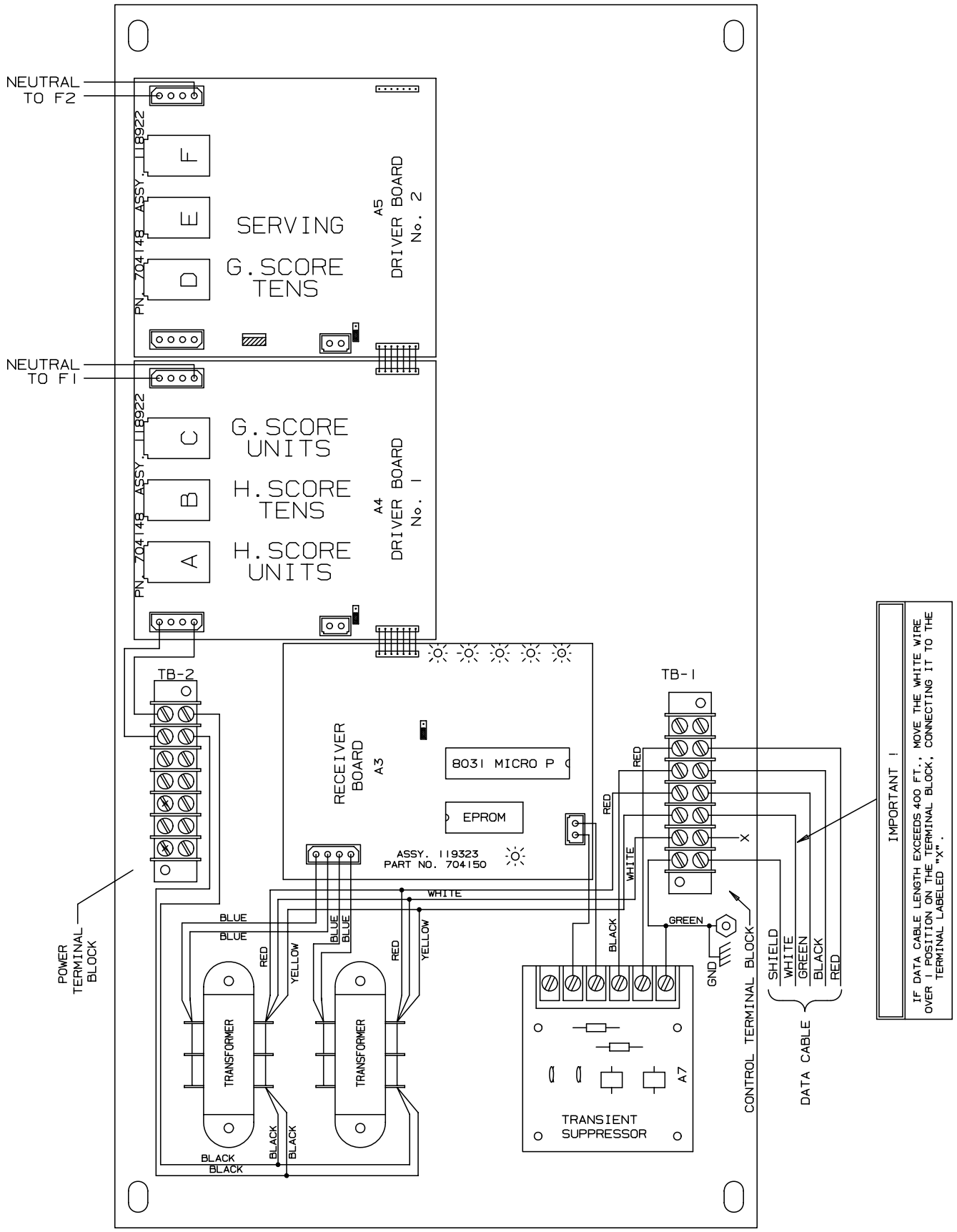

CONTROLLER ASSEMBLY

6.6 Microprocessor 4 X 7 Lamp Pattern (8 Bit)

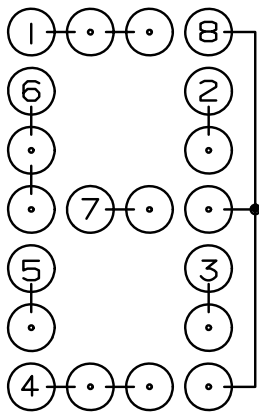
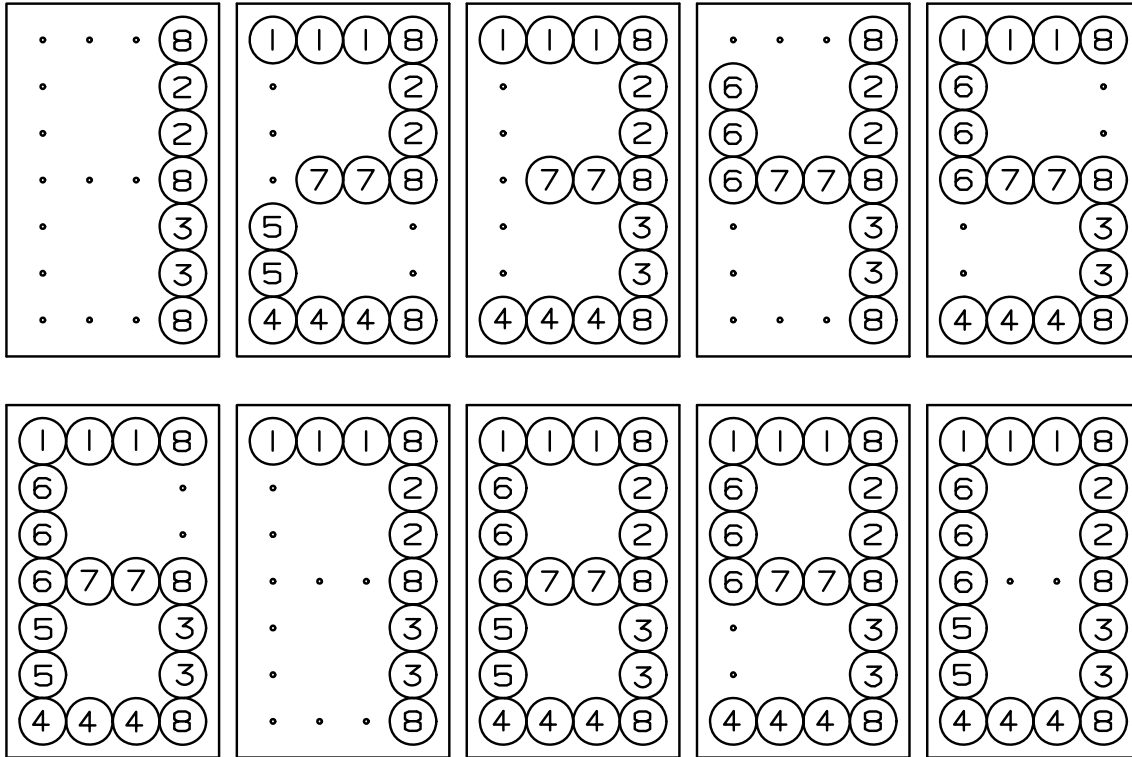

NUMERALS

	0	1	2	3	4	5	6	7	8	9
1	0	.	2	3	.	5	6	7	8	9
2	0	1	2	3	4	.	.	7	8	9
3	0	1	.	3	4	5	6	7	8	9
4	0	.	2	3	.	5	6	.	8	9
5	0	.	2	.	.	.	6	.	8	.
6	0	.	.	.	4	5	6	.	8	9
7	.	.	2	3	4	5	6	.	8	9
8	0	1	2	3	4	5	6	7	8	9

MICROPROCESSOR 4 X 7 (8 BIT) LAMP PATTERN

6.7 Figuregram Wiring

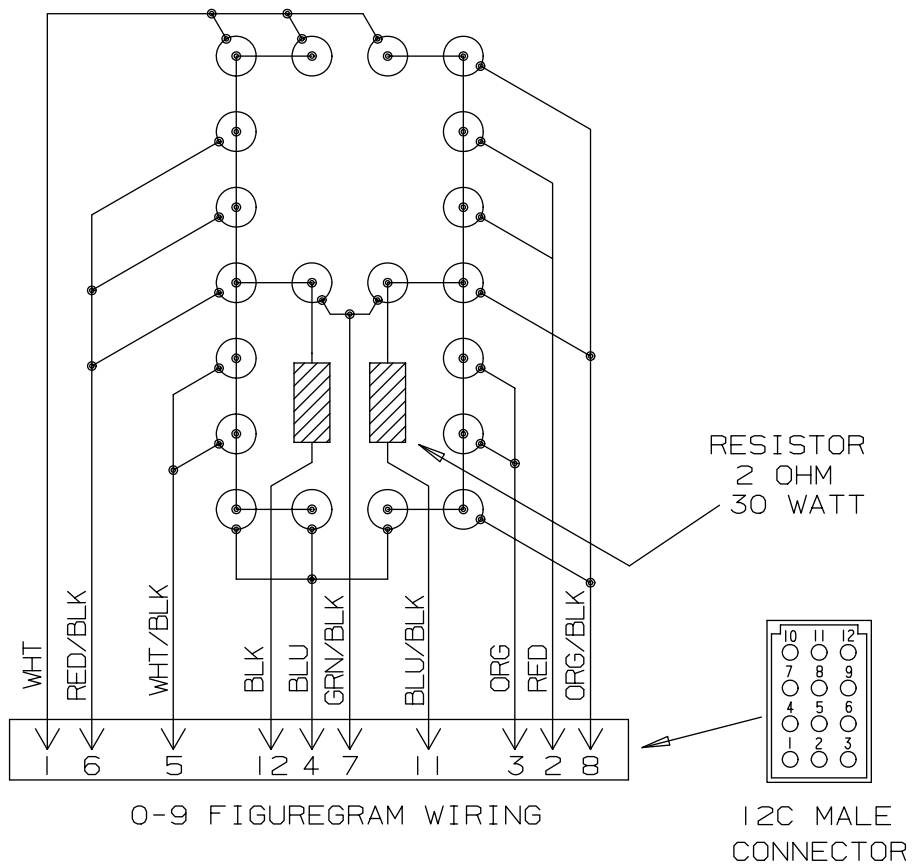
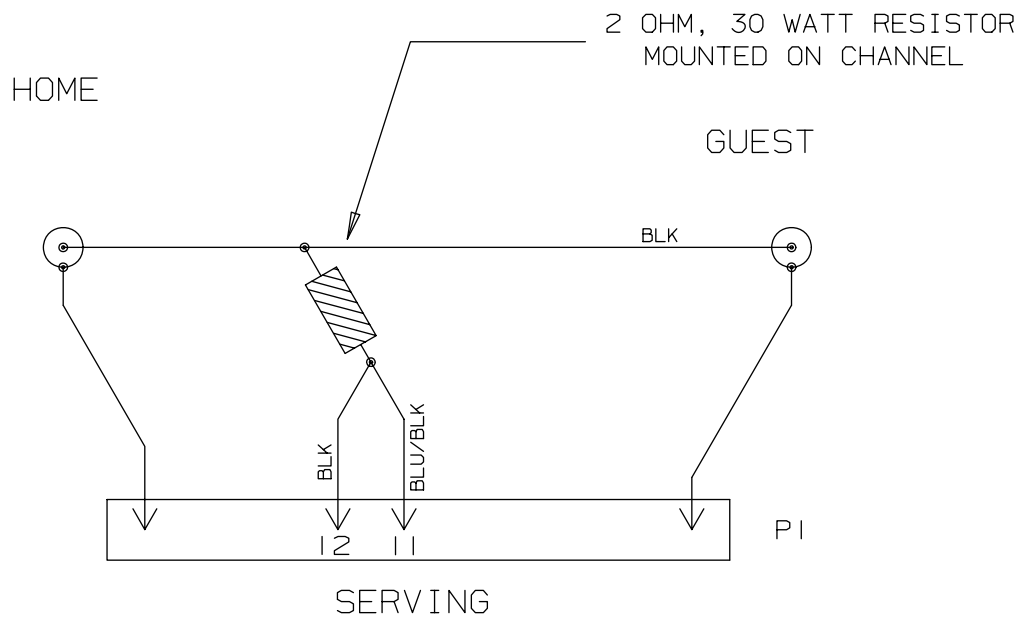

### FIGUREGRAM WIRING

#### 6.8 Jumper Location on 3 Position System

All of the 3 position drivers and receivers are identical except for the jumper on each board. Make sure the jumpers are set for the model of scoreboard you are installing them into.

- (A) On the receiver board (refer to figure); Jumper pins 2 & 3 for models MP-3385, MP-3312, MP-3529, and MP-3549. Jumper pins 1 & 2 for all other models.
- (B) On the driver board (refer to figure); Jumper pins 1 & 2 for use of a horn. Jumper pins 2 & 3 for all others.

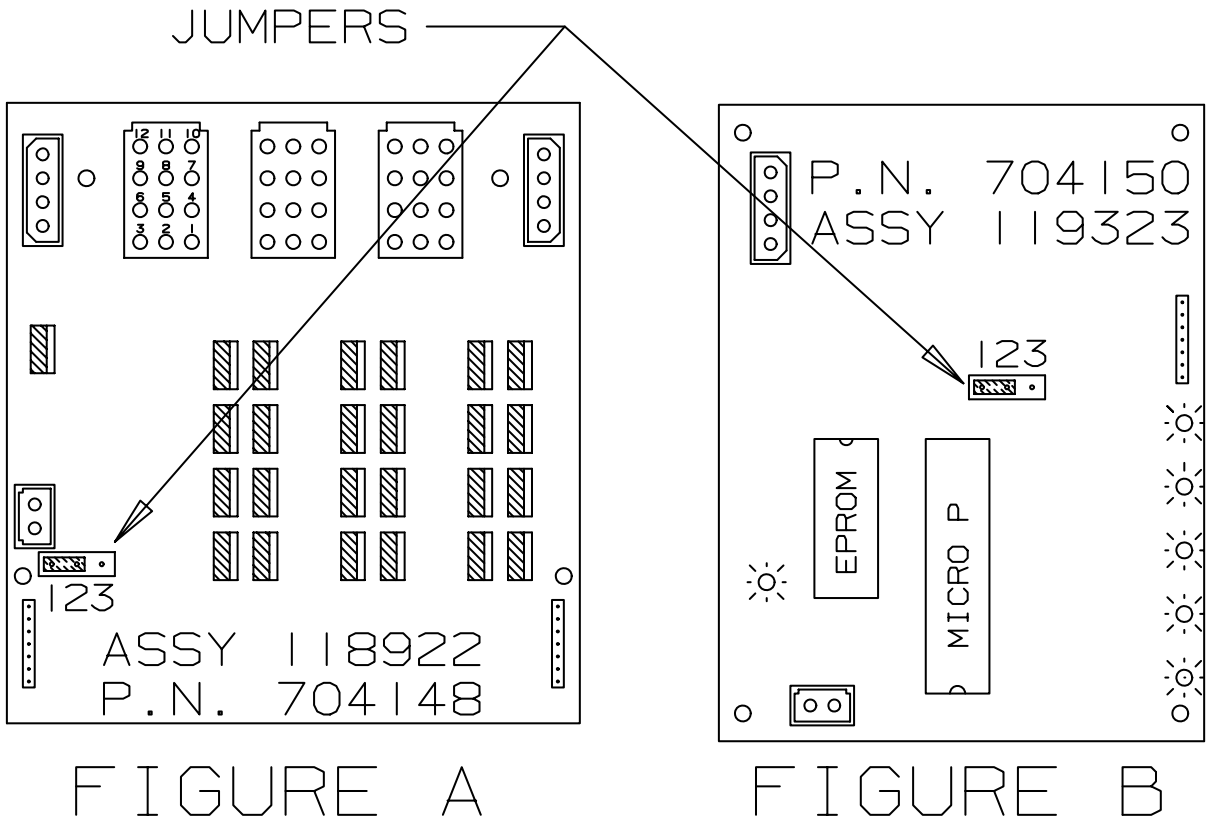

### JUMPER LOCATION

## 6.9 Triac Placement

The triac is the switch that controls the figuregram lamps. The triacs for any given figuregram are adjacent to the twelve pin connector on the driver board that controls that figuregram. Shown below is the triac placement and bit designation relative to the figuregram bit pattern.

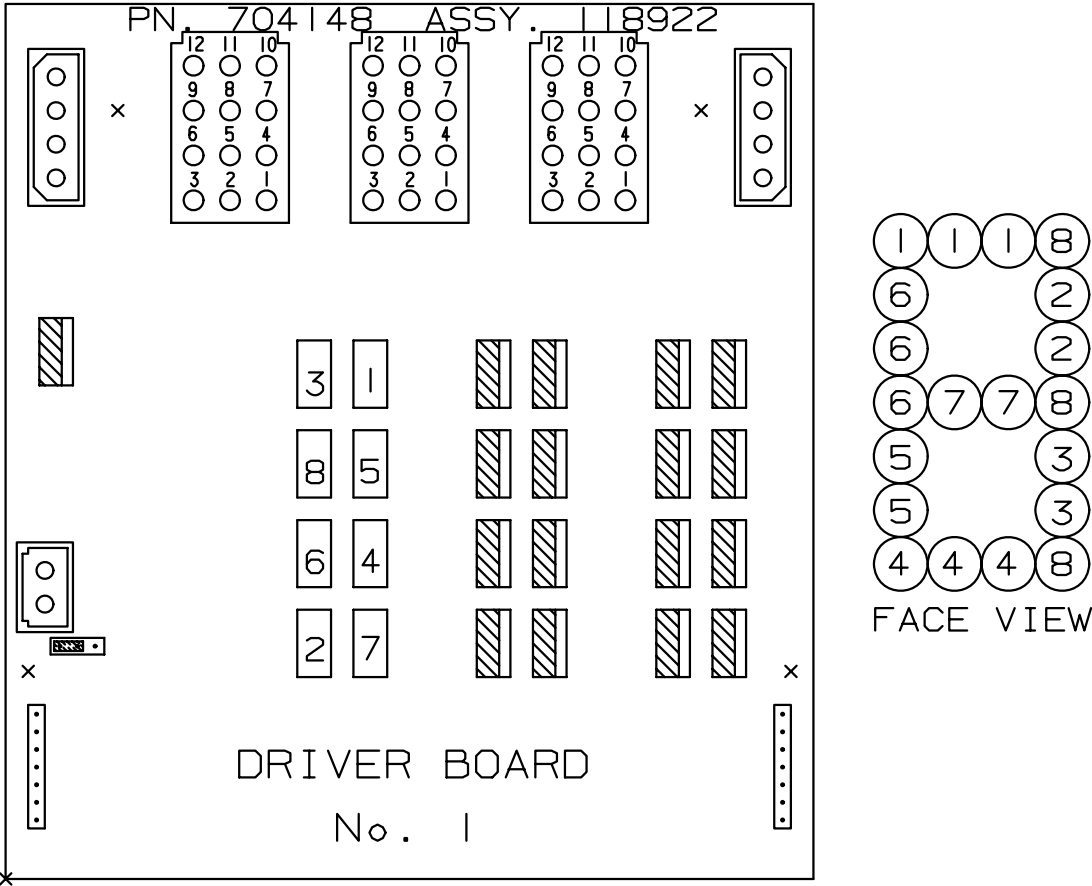

MP TRIAC PLACEMENT

6.10 Installation Drawings

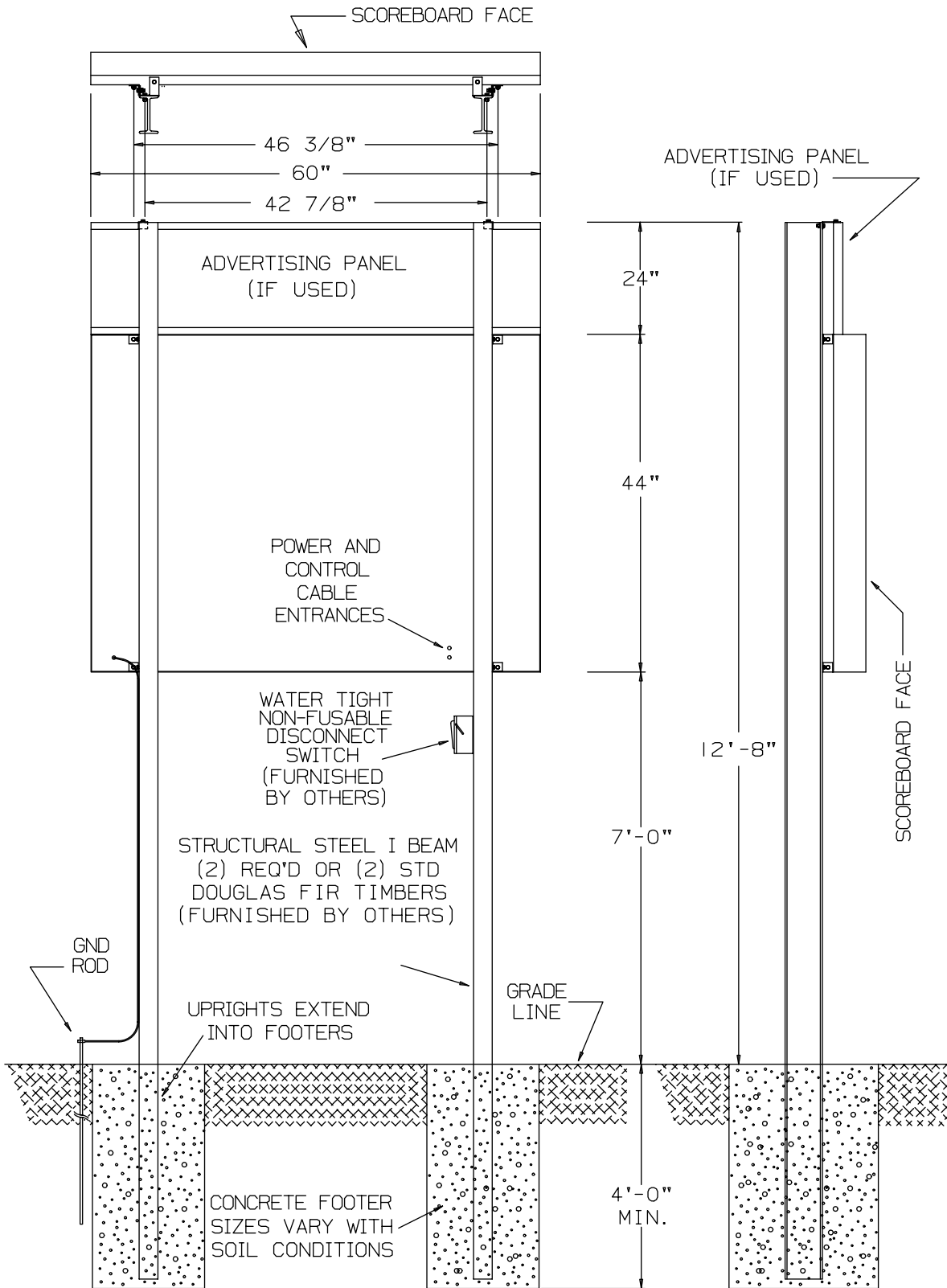

6.10 Installation Drawing Cont.

