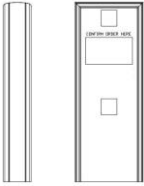
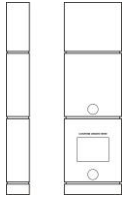
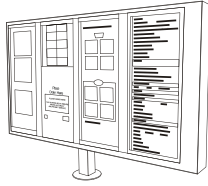
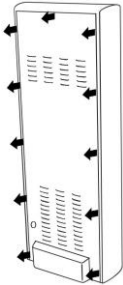
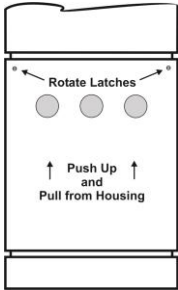
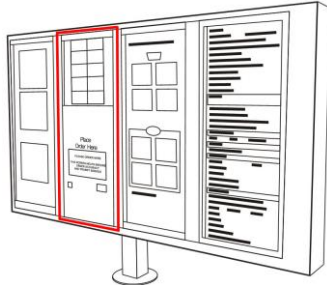

## Remaking OCS Data Cable Connections

v6/24/2016

### Step 1: Accessing the Electronics

Proceed by choosing one of the listed enclosure types:

Freestanding Monolith	Canopy Mount	Menuboard
		
<ol style="list-style-type: none"> <li>1. Remove all rear-panel outside 8-32 Phillips-head or T15 Torx-head screws (1/2") and retain for later:</li> </ol>	<ol style="list-style-type: none"> <li>1. Remove the rear OCS access panel (with vents) by unlocking the two top corner latches and pulling the panel up and away:</li> </ol>	<ol style="list-style-type: none"> <li>1. Open the front OCS access panel by rotating the unlocking latches and swinging the door open:</li> </ol>
		
<ol style="list-style-type: none"> <li>2. Turn off power to the unit by flipping the rear cabinet power switch</li> </ol>	<ol style="list-style-type: none"> <li>2. Turn off power to the unit by flipping the rear cabinet power switch</li> </ol>	<ol style="list-style-type: none"> <li>2. Turn off power to the unit by flipping any internal power switches or the circuit breaker</li> </ol>

### Step 2: Locating Data Cable Connections

The Everbrite data cable in almost all installs has a yellow jacket (in a few installations, it might be black). The data cable comes out from a store, through a conduit and into the OCS/COD enclosure. Tracing the cable up from the conduit, there will be a connection point with one of the following connections:

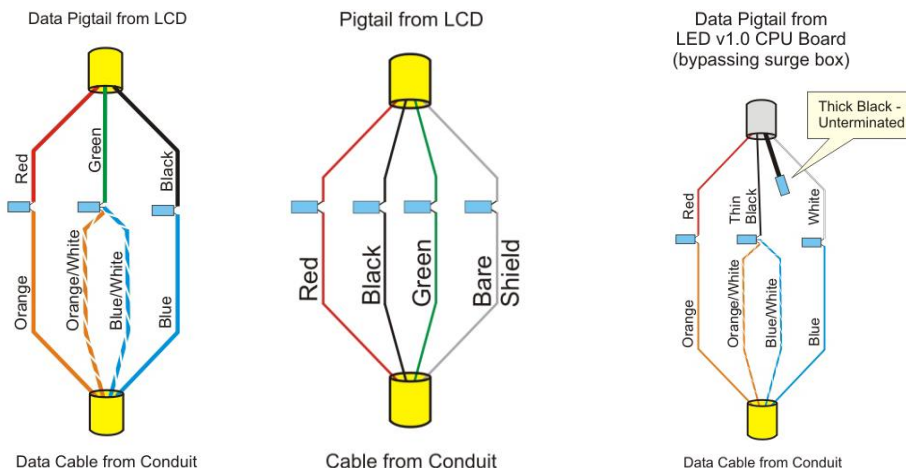

### **Step 3: Replace Each Splicing Connector**

Cut a connector out (shown in blue) and reconnect each set of wires following the instructions below:

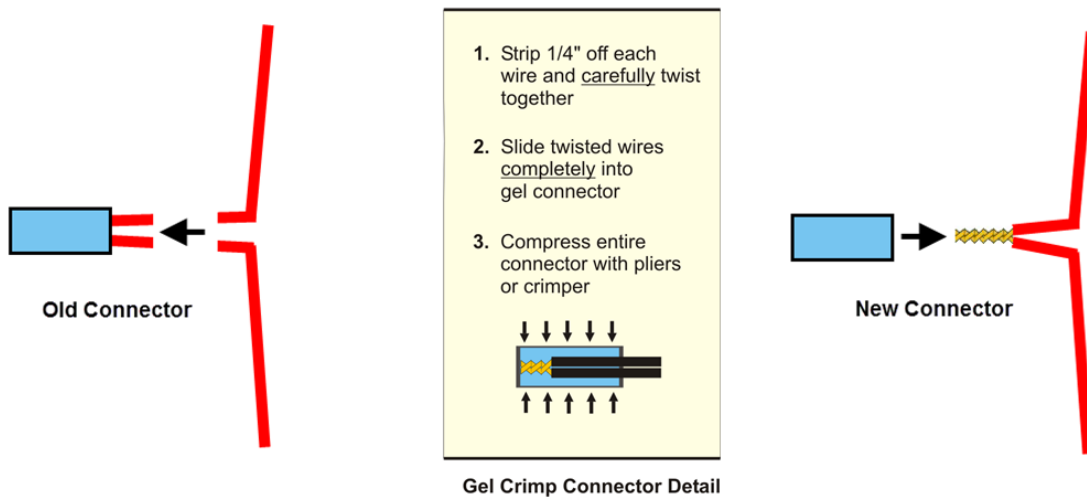

Note: Everbrite recommends Dolphin model # DC-100-S sealed, insulation displacement connectors. Make sure the connector used is compatible with your wires sizes and is, ideally, moisture resistant.

Follow this same procedure for all wire connectors until they are all replaced.

### **Step 4: Replace Any Access Panels**

Work backwards within step 1 to replace and removed or open access panels.